



NAVIENT

Condensing Combi-Boilers

Natural Gas & High Altitude Conversion Guide

(Altitude: 5,400~10,100 ft)

Natural Gas Only - DO NOT USE with Propane Gas

Model

NCB-190/060H NCB-190/080H
 NCB-240/110H NCB-240/130H
 NCB-250/150H

This boiler is configured for Natural Gas at the factory.

- If the boiler is installed at a high altitude (above 5,400 ft) for NG, use the HIGH ALTITUDE CONVERSION KIT supplied with the boiler.

- Note**
- For NG high altitude conversion, use the NATURAL GAS HIGH ALTITUDE CONVERSION KIT.
 - For Propane Gas high altitude conversion, use the PROPANE GAS & HIGH ALTITUDE CONVERSION KIT. Note that the Gas Orifice from the PROPANE GAS & HIGH ALTITUDE CONVERSION KIT covers the boiler's installation at an altitude of 0 to 10,100 ft.

WARNING

Fire and Explosion Hazard

To prevent serious injury or death:

- ONLY a qualified installer, service agency, or the gas supplier* is required to install a conversion kit in accordance with Navien's instructions and all applicable codes and requirements of the authority having jurisdiction.
- The qualified installer, service agency, or the gas supplier* is responsible for the proper installation of this kit. The installation is not proper and complete until the operation of the converted appliance is checked as specified in the manufacturer's instructions supplied with the kit.

BEFORE starting the gas conversion:

- ALWAYS turn off electrical power supply to the boiler and close the manual gas shut-off valve.
- ALLOW boiler to cool if it has been operating.

* A qualified installer, service agency, or the gas supplier is any individual, firm, corporation or company which either in person or through a representative is engaged in and is responsible for the connection, utilization, repair or servicing of gas utilization equipment or accessories; who is experienced in such work, familiar with all precautions required, and has complied with all of the requirements of the authority having jurisdiction.

In Canada: The conversion shall be carried out in accordance with the requirements of the provincial authorities having jurisdiction and in accordance with the requirements of the CAN-B149.1 and CAN1-B149.2 Installation Code.

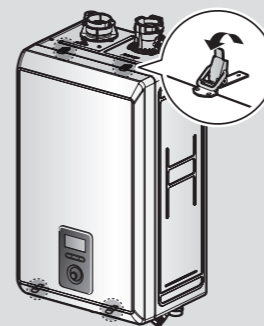

Figure 1. NCB-H Series Front Cover

- Remove the front cover and place it in a safe location to prevent accidental damage.
- With the internal components exposed, locate the gas inlet pipe and the gas valve, as shown in Figure 2.

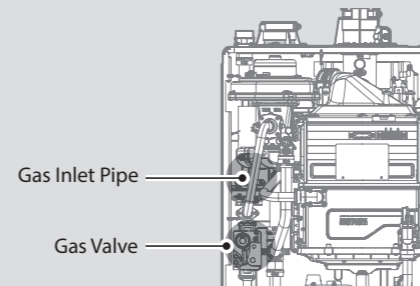

Figure 2. NCB-H Series Internal Components

- Use a Phillips screwdriver to remove the two screws at location A - the connection below the gas valve where it connects to the pipe. See Figure 3 for reference. Once the screws are removed, carefully separate the pipe from the gas valve.

- Once the gas inlet pipe is detached from the gas valve, find location B - the connection above the gas valve where it is attached to the fan motor assembly. Carefully remove the four screws by hand using a Phillips screwdriver and pull the gas valve away from the fan assembly to access the gas orifice.

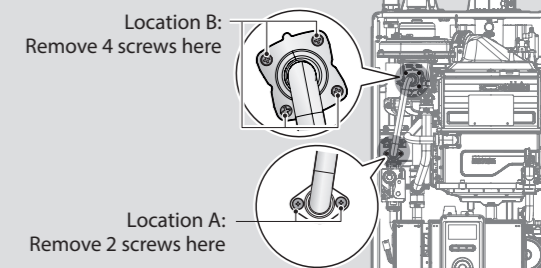

Figure 3. Detaching Gas Valve from Gas Inlet Pipe and Fan Motor Assembly

- Once the Gas Orifice is exposed, remove the two screws that hold the part in place. Remove the Gas Orifice from its housing and prepare the new Gas Orifice for the High Altitude conversion for installation.

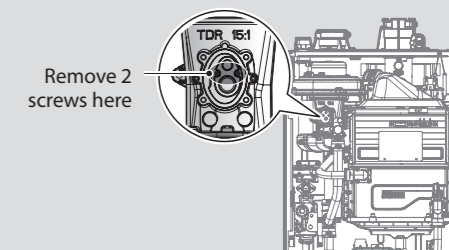

Figure 4. Access to Gas Orifice in Fan Assembly

Tools Required:

- Phillips Screwdriver
- Flathead Screwdriver
- 3/32 in or 4 mm Allen Wrench
- Combustion Analyzer or Dual Port Manometer
- Gas Leak Detector

Included Items:

- Gas Orifice (refer to below table)

Note

Please confirm the installation elevation by using the provided QR code to access the following website (<https://www.navieninc.com/elevation>) and entering the proper zip/postal code.



WARNING

Fire and Explosion Hazard

To prevent serious injury or death:

- Be careful not to confuse the PROPANE GAS & HIGH ALTITUDE CONVERSION KIT and NATURAL GAS HIGH ALTITUDE CONVERSION KIT. Do NOT use the NATURAL GAS HIGH ALTITUDE CONVERSION KIT for natural gas when converting to propane gas.
- Make sure that the conversion is completed with the proper orifice. If the installed orifice does not conform to the specifications in Table 1, incomplete combustion may occur, resulting in personal injury or property damage.

Procedure:

- Turn off both gas and water supply to the boiler.
- Unfasten the 4 latches (2 at the top and 2 at the bottom) to remove the front cover and gain access to the internal components.

WARNING

Fire and Explosion Hazard

To prevent serious injury or death:

- DO NOT adjust or attempt to measure gas valve outlet pressure. The gas valve is factory set for the correct outlet pressure. This setting is suitable for natural gas and propane, requiring no field adjustment.
- Attempting to alter or measure the gas valve outlet pressure could result in damage to the valve, causing potential severe personal injury, death or substantial property damage. Navien water heaters are shipped ready to fire natural gas ONLY.

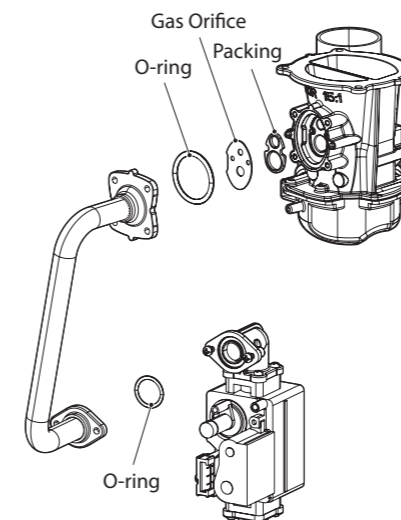

Figure 5. Exploded View of Gas Pipe Assembly

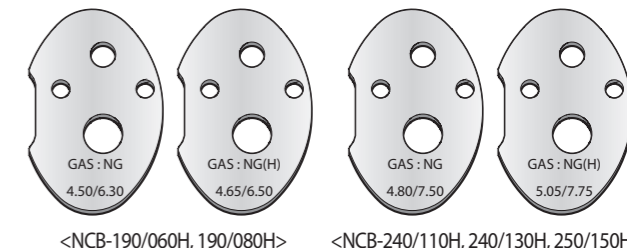
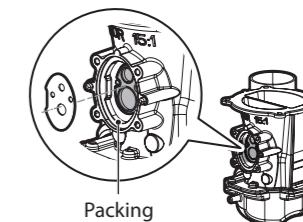

Figure 6. Orifice Identification

- Remove the Gas Orifice, ensure that the packing is properly seated inside the port, and then install the new Gas Orifice for use with NG at a high altitude. Ensure that the Orifice is properly seated on the packing inside the port before proceeding to the next step.



- Replace the gas valve outlet adapter to its original position and use all screws to secure all connections.

- Note** Do not overtighten as this may damage or crack the components.

NCB-190/060H, 190/080H Orifice Identification

Gas Type	NG	
Altitude	0-5,399 ft	5,400-10,100 ft
Orifice		
Orifice Size	Ø4.50/Ø6.30	Ø4.65/Ø6.50

NCB-240/110H, 240/130H, 250/150H Orifice Identification

Gas Type	NG	
Altitude	0-5,399 ft	5,400-10,100 ft
Orifice		
Orifice Size	Ø4.80/Ø7.50	Ø5.05/Ø7.75

Table 1. Orifice Size

1 3
2 4

⚠ DANGER

Fire and Explosion Hazard

To prevent serious injury or death:

- ALWAYS inspect the O-ring between the gas valve and gas valve inlet adapter whenever they are disassembled (see Figure 5).
- The O-ring must be in good condition and must be installed. Replace O-ring if needed.

10. Set the PCB DIP switches by altitude according to the table in the warning below.

⚠ WARNING

Ensure that you have turned off the power to the boiler before accessing the DIP switches.

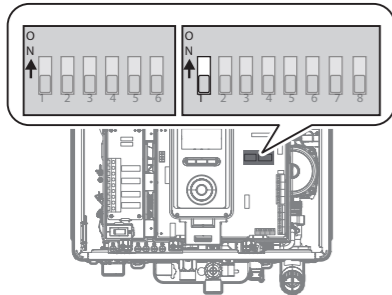

⚠ WARNING

Switch	Function	Setting	Comment
2&3	High Altitude	0-1,999 ft (0-609 m)	2-OFF, 3-OFF
		2,000-5,399 ft (610-1,645 m)	2-ON, 3-OFF
		5,400-7,699 ft (1,646-2,346 m)	2-OFF, 3-ON
		7,700-10,100 ft (2,347-3,078 m)	2-ON, 3-ON

Refer to Table 1 on page 2.

Note

- This unit may be installed at elevations up to 10,100 ft (3,078 m) for use with natural gas and propane. To use the unit at a specific altitude, the DIP Switches should be set as described above.
- Please confirm the installation elevation by using the provided QR code to access the following website (<https://www.navieninc.com/elevation>) and entering the proper zip/postal code.
- High Altitude: Above 2,000 ft (610 m), the unit will de-rate by 3% for each 1,000 ft (305 m) of altitude gain.



- c. Activate multiple zones and set the boiler to operate at 1-stage MIN mode. Measure the CO₂ value at low fire. If the CO₂ value is not within 0.5% of the value listed in Table 2, the gas valve set screw will need to be adjusted. If adjustment is necessary, locate the set screw as shown in Figure 8. Using a ⁵/₃₂ in or 4 mm Allen wrench, turn the set screw no more than ¹/₄ turn clockwise to raise or counterclockwise to lower the CO₂ value.

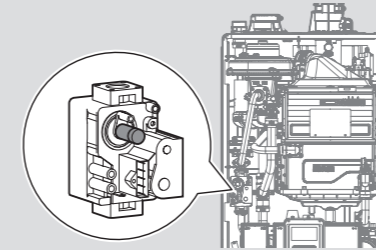

Figure 8. Set Screw Location

Note

The set screw is located behind the screw-on cover. This must be removed first.

- d. Activate multiple zones and set the boiler to operate at 2-stage D. MAX mode. Measure the CO₂ value at high fire. If the CO₂ values do not match Table 2 at high fire, do not adjust the gas valve. Check for the proper Gas Orifice.

⚠ DANGER

Improper gas valve settings can cause severe personal injury, death or substantial property damage.

Option 2. Using Digital Manometer

- a. Open the offset pressure port by loosening the screw two turns as shown in Figure 9.

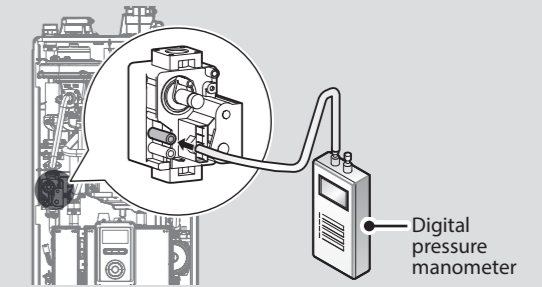

Figure 9. Connect Digital Pressure Monometer

- b. Connect a manometer to the offset pressure port. For dual port manometers, use the positive pressure side.

Model	Altitude	Kit Part No.	Gas Type	Offset
NCB-190/080H NCB-190/060H	0 - 5,399 ft	-	NG	-0.01 in ± 0.01 in
	5,400 - 10,100 ft	NAC-NH190/080		
NCB-240/130H NCB-240/110H	0 - 10,100 ft	NAC-L190/080	LP	-0.04 in ± 0.01 in
	0 - 5,399 ft	-	NG	-0.06 in ± 0.01 in
5,400 - 10,100 ft	NAC-NH240/130			
NCB-250/150H	0 - 10,100 ft	NAC-L240/130	LP	-0.06 in ± 0.01 in
	0 - 5,399 ft	-	NG	-0.06 in ± 0.01 in
5,400 - 10,100 ft	NAC-NH250/150			
NCB-250/150H	0 - 10,100 ft	NAC-L250/150	LP	-0.06 in ± 0.01 in

Table 3. Offset value for low fire

5 7
6 8

⚠ WARNING

To prevent serious injury or death:

- ALWAYS check the panel DIP switch 1 is set according to the supply gas type.
- For natural gas, only install the gas orifice for high altitude when the water heater is installed at above 5,400 ft.
- Be careful to install the Natural Gas High Altitude Conversion Kit and not to confuse it with the Propane Gas Conversion Kit.
- Failure to properly install the High Altitude Conversion Kit or to not use the appropriate Altitude Settings could cause carbon monoxide poisoning, resulting in serious injury or death.

⚠ DANGER

- For NG, use the Gas Orifice for high altitude when the boiler is installed at above 5,400 ft. Verify the proper orifice by checking the label on the part.
- Note that the Gas Orifice from the PROPANE GAS & HIGH ALTITUDE CONVERSION KIT covers the boiler's installation at an altitude of 0 to 10,100 ft.
- Failure to properly set the DIP switches could cause carbon monoxide poisoning, resulting in severe personal injury or death.

11. Turn on the gas and water supply to the boiler.

12. Measure and adjust the gas/air ratio.

Option 1. Using Combustion Analyzer (recommended)

- a. Loosen the screw, rotate the plate and remove the gasket to access the emissions monitoring port as shown in Figure 7.
- b. Insert the analyzer into the port (Figure 7).

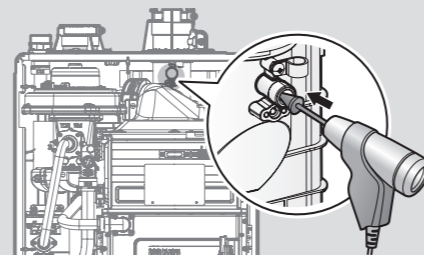

Figure 7. Insert the Analyzer

Model	Altitude	Fuel	High fire	Low fire
			%CO ₂	%CO ₂
NCB-190/060H NCB-190/080H	0-5,399 ft	NG	9.1	9.3
		LP	10.5	10.7
NCB-240/110H NCB-240/130H NCB-250/150H	5,400-10,100 ft	NG	9.1	9.3
		LP	10.5	10.7
NCB-240/110H NCB-240/130H NCB-250/150H	0-5,399 ft	NG	9.1	9.3
		LP	10.5	10.7
NCB-240/110H NCB-240/130H NCB-250/150H	5,400-10,100 ft	NG	9.1	9.3
		LP	10.5	10.7

Table 2. CO₂ value
(CO₂ values must be within 0.5% of the values listed.)

- c. Activate multiple zones and set the boiler to operate at 1-stage MIN mode. Measure the offset value at low fire and compare it to the values in Table 3. If the offset value is out of range, the gas valve set screw will need to be adjusted. If adjustment is necessary, locate the set screw as shown in Figure 10. Using a ⁵/₃₂ in or 4mm Allen wrench, turn the set screw no more than ¹/₄ turn clockwise to raise or counterclockwise to lower the offset value.

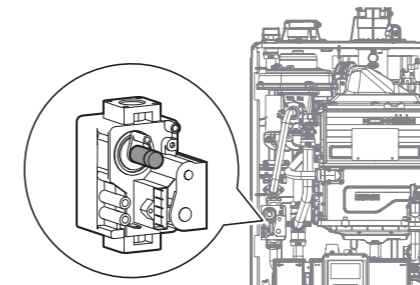

Figure 10. Set Screw Location

Note

The set screw is located behind the screw-on cover. This must be removed first.

- d. At high fire, do not check the offset value and never adjust the gas valve.

⚠ DANGER

Improper gas valve settings can cause severe personal injury, death or substantial property damage.

13. Once the CO₂ or offset values have been confirmed, apply the included conversion stickers to show that the appliance has been converted to High Altitude. Place these labels adjacent to the rating plate as shown in Figure 11.

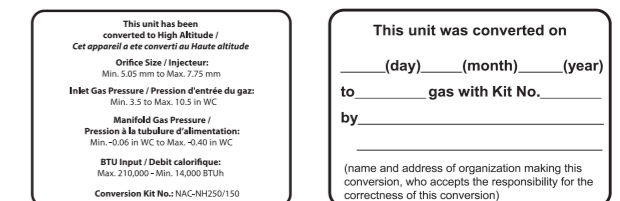

Figure 11. Proper Placement of High Altitude Conversion Labels

Note

The high altitude conversion rating plate varies depending on the model. Check the conversion kit number before attaching the labels.

NAVIENT

Navien, Inc.

20 Goodyear Irvine, CA 92618

TEL 1-800-519-8794 FAX 1-949-420-0430

www.NavienInc.com