

# User's Information Manual

## NHB Condensing Boilers

**Model** | NHB-055  
NHB-080  
NHB-110  
NHB-150



Keep this manual near this boiler for future reference whenever maintenance or service is required.



### WARNING

If the information in these instructions is not followed exactly, a fire or explosion may result, causing property damage, personal injury, or death.

**Do not store or use gasoline or other flammable vapors and liquids in the vicinity of this or any other appliance.**

### WHAT TO DO IF YOU SMELL GAS

- Do not try to light any appliance.
- Do not touch any electrical switch; do not use any phone in your building.
- Immediately call your gas supplier from a neighbor's phone. Follow the gas supplier's instructions.
- If you cannot reach your gas supplier, call the fire department.

**Installation and service must be performed by a qualified installer, service agency or the gas supplier.**

**The installation must conform with local codes or, in the absence of local codes, the National Fuel Gas Code, ANSI Z223.1/NFPA 54 and/or CSA B149.1, Natural Gas and Propane Installation Code.**

# Contents

---

<b>1. Safety Information</b>	<b>3</b>
<b>2. About the Boiler</b>	<b>6</b>
2.1 Description of the Boiler	6
2.2 Parts of the Boiler	6
2.3 The Front Panel	7
<b>3. Operating the Boiler</b>	<b>9</b>
3.1 Turning the Boiler On or Off	9
3.2 Adjusting the Temperature	9
3.3 Viewing Basic Information	10
3.4 Resetting the Boiler	11
<b>4. Maintaining the Boiler</b>	<b>12</b>
4.1 Cleaning the Boiler	12
4.2 Draining the Boiler	12
4.3 Cleaning the Air Intake Filter	13
4.4 Protecting the Boiler from Freezing	15
4.5 Maintenance Schedules	16
<b>5. Troubleshooting</b>	<b>21</b>
5.1 Solving Basic Problems	21
5.2 Understanding Error Codes	22

# 1. Safety Information

The following safety symbols are used in this manual. Read and follow all safety instructions in this manual precisely to avoid unsafe operating conditions, fire, explosion, property damage, personal injury, or death. Keep this manual for future reference.

## DANGER

Indicates an imminently hazardous situation which, if not avoided, could result in severe injury or death.

## WARNING

Indicates a potentially hazardous situation which, if not avoided, may result in injury or death.

## CAUTION

Indicates a potentially hazardous situation that, if not avoided, could result in property damage.

## WARNING

If you do not follow these instructions exactly, a fire or explosion may result causing property damage, personal injury or loss of life.

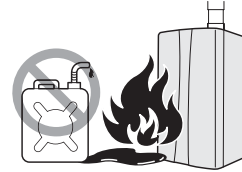

A. This appliance does not have a pilot. It is equipped with an ignition device which automatically lights the burner. Do not try to light the burner by hand.

B. BEFORE OPERATING smell all around the appliance area for gas. Be sure to smell next to the floor because some gas is heavier than air and will settle on the floor.

### WHAT TO DO IF YOU SMELL GAS

- Do not try to light any appliance.
- Do not touch any electric switch; do not use any phone in your building.
- Immediately call your gas supplier from a neighbor's phone. Follow the gas supplier's instructions.
- If you cannot reach your gas supplier, call the fire department.
- Do not return to your home until authorized by your gas supplier or the fire department.

C. Do not use this appliance if any part has been under water. Immediately call a qualified service technician to inspect the appliance and to replace any part of the control system and any gas control which has been under water.

D. Do not use this appliance if any part has been under water. Immediately call a qualified service technician to inspect the appliance and to replace any part of the control system and any gas control which has been under water.

 **DANGER**



**To prevent burns:**

- Use the lowest operating temperature setting necessary to provide comfortably-hot water.
- If your household has children or elderly or disabled residents, consider using a lower temperature setting.
- Do not leave children, the elderly, or disabled persons unsupervised.
- Do not allow small children to play unsupervised in the bathroom.
- Do not allow anyone to change the water temperature while hot water is running.
- Read all the instructions in this manual carefully before changing the temperature setting.
- Feel the water before using it on children, the elderly, or the disabled.
- If it is necessary to set the water temperature above 125°F (52°C), consider installing a thermostatically-controlled mixing valve or temperature-limiting valve. Contact a licensed plumber or your local plumbing authority for more information.

 **DANGER**

This boiler's water temperature is set to 120°F (49°C) at the factory for your safety and comfort. Increasing the temperature increases the risk of accidental scalding. Water temperatures at or above 125°F (52°C) can cause instant scalding, severe burns, or death. Before you decide to change the temperature setting, read the following charts carefully.

Water Temperature	Time in which a young child can suffer a full thickness (3rd degree) burn
160°F (70°C)	Less than 1 second
140°F (60°C)	1 second
130°F (55°C)	10 seconds
120°F (49°C)	10 minutes
100°F (37°C)	very low scald risk

California law requires the following Prop 65 warning to be provided:

 **WARNING**

This product can expose you to chemicals including lead, lead compounds, and carbon bisulfide which are known to the State of California to cause cancer and birth defects or other reproductive harm. For more information, go to [www.P65Warnings.ca.gov](http://www.P65Warnings.ca.gov).

## WARNING

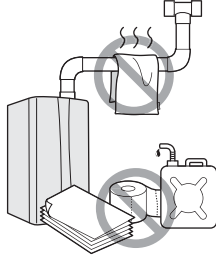

- **Shut off the gas supply if the boiler is damaged.**  
Have your installer or plumber show you the location of the gas shut off valve and demonstrate how to close the valve. If the boiler is damaged as a result of overheating, fire, flood, or any other reason, close the manual shut off valve and do not operate the boiler again until it has been inspected by a qualified technician.
- **Do not store or use gasoline or other flammable liquids near this boiler.**  
Doing so may result in fire or explosion.
- **Do not place combustibles, such as newspapers or laundry, near the boiler or venting system.**  
Doing so may result in a fire.
- **Do not place or use hair sprays, spray paints, or any other compressed gases near the boiler or venting system, including the vent termination.**  
Doing so may result in fire or explosion.
- **Do not operate the boiler with the front cover opened.**  
Doing so may result in fire or carbon monoxide (CO) poisoning, which may result in property damage, personal injury, or death.
- **Do not operate this boiler without proper venting.**  
Doing so may result in fire or carbon monoxide (CO) poisoning, which may result in property damage, personal injury, or death. Inspect the vent termination and air intake supply annually to ensure proper operation of the boiler. Turn off and discontinue use of the boiler if any of the vent pipes, vent elbows, or intake pipes are damaged in any way, separated at a joint, or show evidence of corrosion, rusting, or melting.
- **Do not touch the power cord or internal components of the boiler with wet hands.**  
Doing so may result in electric shock.
- **Do not make any electrical connections before turning off the electrical power supply at service entrance panel.**  
Doing so may result in severe personal injury or death.

## CAUTION

- **Do not attempt to repair or replace any part of the boiler, unless it is specifically recommended in this manual.**  
For all other service, contact an authorized technician or licensed professional. Improper adjustments, alterations, service, or maintenance may lead to property damage, personal injury, or death and will void your warranty.
- **Do not operate the boiler if you feel something is wrong with it.**  
Doing so may result in product damage or personal injury.
- **Do not allow children to operate or access the boiler.**  
Doing so may result in product damage or personal injury.
- **Do not attempt to change the DHW water temperature while the boiler is being used.**  
Doing so may result in personal injury.
- **Do not turn on the boiler unless the water and gas supplies are fully opened.**  
Doing so may damage the boiler.
- **Do not turn on the water if the cold water supply shutoff valve is closed.**  
Doing so may damage the boiler.
- **Do not use this boiler for anything other than its intended purpose, as described in this manual.**
- **Do not remove the front cover unless the power to the boiler is turned off or disconnected.**  
Failure to do so may result in electric shock.
- **When servicing the controls, label all wires prior to disconnecting them.**  
Failure to do so may result in wiring errors, which can lead to improper or dangerous operation.
- **Do not use unapproved replacement or accessory parts.**  
Doing so may result in improper or dangerous operation and will void the manufacturer's warranty.
- **Do not place anything in or around the vent terminals, such as a clothes line, that could obstruct the air flow in or out of the boiler.**
- **This boiler has been approved for use in the USA and Canada only.**  
Using the boiler in any other country will void the manufacturer's warranty.
- **Should overheating occur or the gas supply fail to shut off, turn off the manual gas valve to the appliance.**

## 2. About the Boiler

### 2.1 Description of the Boiler

The Navien NHB boiler is available in 4 models: NHB-055, NHB-080, NHB-110 and NHB-150.

The main features are as follows:

- **Power Interruption:** When the power is restored after a power failure, the boiler will automatically start and return to normal operation. A manual reset is not required.
- **Freeze Protection:** A sensor inside the boiler automatically detects the temperature and, if necessary, initiates a safety heating cycle to prevent internal equipment damage due to freezing temperatures.
- **Short-Circuit Protection:** Any short-circuit occurring in the boiler's electrical circuit immediately blows the internal glass fuses and automatically cuts off the gas supply.
- **Lightning Protection:** Each boiler is specially grounded, both internally and externally, to protect against lightning strikes.
- **Carbon Monoxide Protection:** The boiler is designed to maintain a safe air-to-gas ratio and combustion rate. This function is continuously monitored by the boiler's air ratio control module.
- **Auto Fan Detection:** The rotation of the fan is automatically detected and controlled. Fan failure will stop the operation of the boiler.
- **Boiling Prevention:** Excessive temperatures will automatically stop the boiler.

### 2.2 Parts of the Boiler

#### 2.2.1 Front View

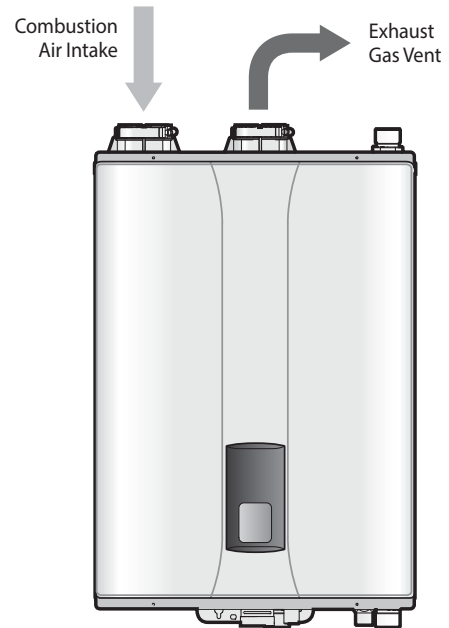

#### 2.2.2 Bottom View

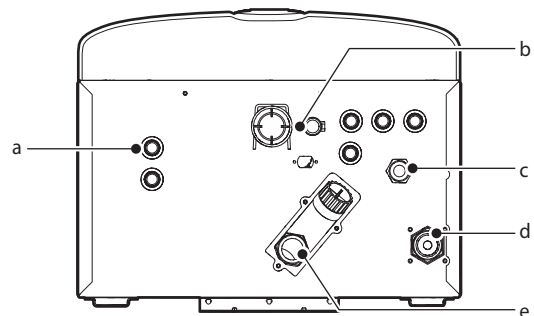

#	Description
a	Rubber Grommets
b	Condensate Outlet
c	Gas Connection
d	Space Heating Supply Connection
e	Space Heating Return Connection

## 2.3 The Front Panel

The front panel allows you to adjust the temperature and view the operating status or error codes. Remove the protective sheet from the front panel before using it.

### 2.3.1 Icons and Digital Display

The icons and digital display on the front panel provide important information required for the boiler's operation. Refer to the following table for detailed information.

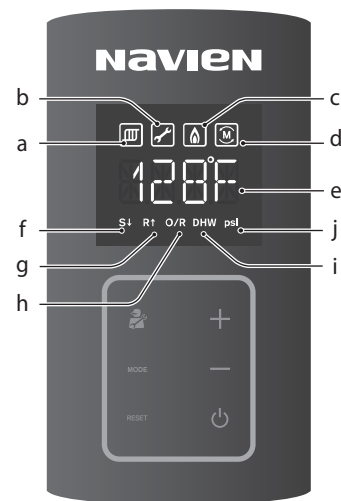

**Space heating mode**

Indicates space heating mode operation.



**Error**

A code will appear on the display.



**Combusting**

Indicates burner operation.



**Master Unit**

Indicates Cascade mode operation.



**Digital Display**

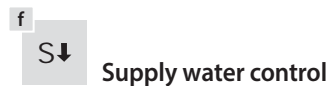

**Supply water control**

Indicates supply water control status.



**Return water control**

Indicates return water control status.



**Outdoor Reset**

Indicates outdoor reset operation.



**DHW Mode**

Indicates DHW priority mode operation.



**Psi**

Indicates water pressure.

### 2.3.2 Buttons

Using the buttons on the front panel, you can turn on or off the boiler, monitor the current operation status, and set the values required for the boiler's operation, such as space heating and DHW supply temperatures. Refer to the following table for detailed information.

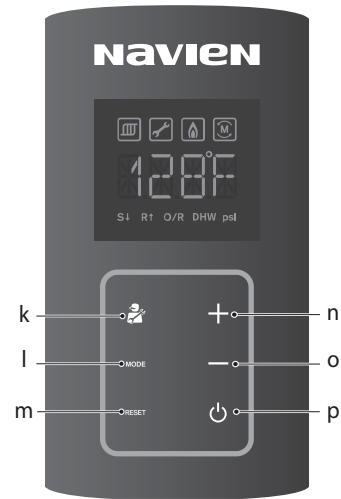

---

**k**  
 **Diagnostics button**

For installers only

---

**l**  
 **Mode button**

Changes the mode.

---

**m**  
 **Reset button**

Resets the boiler (if an error occurs).

---

---

**n**  
 **Up button**

Increases the temperature.

---

**o**  
 **Down button**

Decreases the temperature.

---

**p**  
 **Power button**

Turns the boiler on or off.

---



## 3. Operating the Boiler



### WARNING

Follow the instructions below to avoid unsafe operating conditions that could cause property damage, severe personal injury, or death.

- Ensure that the boiler is filled with water before turning it on.
- If overheating occurs or the gas supply fails to shut off, shut off the gas supply to the boiler by using the manual gas valve.
- If any part of the boiler has been submerged in water, do not use this appliance and immediately call a qualified service technician. The boiler must be replaced.

### 3.1 Turning the Boiler On or Off

To turn the boiler on or off, press the Power button for 0.3 seconds.

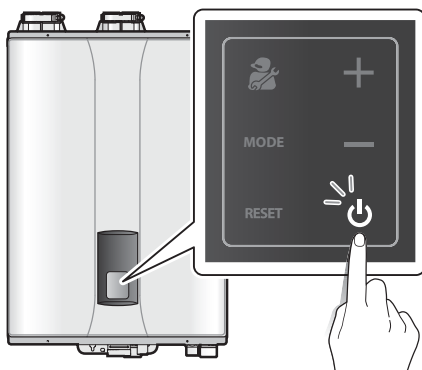

When the power is on, the boiler supply water temperature will appear with the water pressure on the front panel display in 5 second intervals.

**Note** When displaying the boiler supply water temperature, the supply or return water icon turns on, depending on the space heating control mode.

## 3.2 Adjusting the Temperature

### 3.2.1 Adjusting the Space Heating Temperature

To adjust the heating temperature:

1. Press the Mode button once. The space heating mode icon turns on.

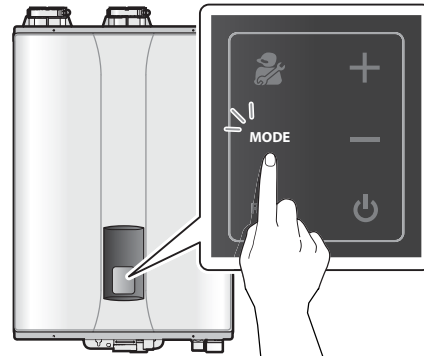

2. Press the + (Up) or – (Down) buttons until the desired temperature appears on the display.

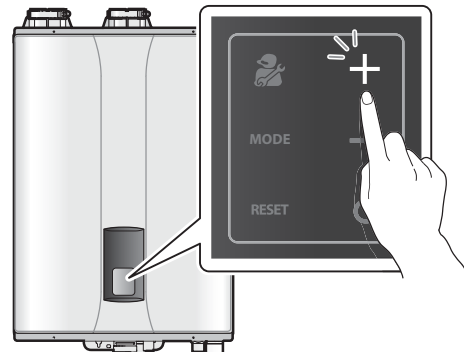

You can adjust the temperature while the display is flashing. Once the display stops flashing, the temperature setting is stored.

**Note**

- The Outdoor Reset Control will take precedence over this temperature setting.
- In case of outdoor reset sensor malfunction, the boiler will operate at this set temperature.
- Take note of the original heating temperature in case you want to restore it to the default.
- The default space heating supply water temperature range is 104°F (40°C, Absolute MIN) to 180°F (82°C, Absolute MAX).
- The default space heating return water temperature range is 86°F (30°C, Absolute MIN) to 149°F (65°C, Absolute MAX).
- You can adjust the temperature range in the parameter settings menu.
- The boiler will retain your settings during a power outage.

### 3.2.2 Adjusting the DHW Indirect Supply Temperature



#### WARNING

Before adjusting the water temperature, read “To prevent burns:” on page 4 carefully. Water above 120°F can cause instant scalding, severe burns, or death.

To adjust the water temperature:

1. Press the Mode button twice. The DHW mode icon turns on.
2. Press + (Up) or – (Down) buttons until the desired temperature appears on the display.

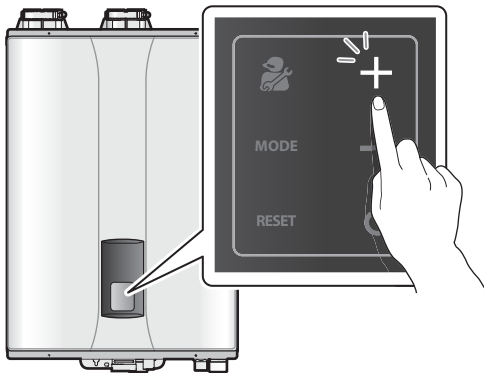

You can adjust the temperature while the display is flashing. Once the display stops flashing, the temperature setting is stored.

#### Note

- Take note of the original DHW temperature in case you want to restore it to the default.
- The default DHW temperature range is 104°F (40°C, Absolute MIN) to 180°F (82°C, Absolute MAX).
- You can adjust the temperature range in the parameter settings menu.
- The boiler will retain your settings during a power outage.



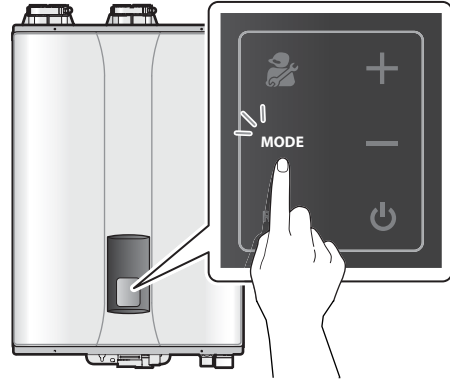

### 3.3 Viewing Basic Information

To view information about the boiler, press the Mode button three times. “INFO” will appear on the display.

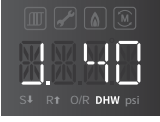
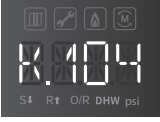

Press the + or – buttons to switch between the information types.

Display	Description
	Space heating supply water temperature (°F)
	Space heating return water temperature (°F)
	Outdoor air temperature (°F) (from Outdoor Temperature Sensor)
	Outdoor reset curve -: Not in use. 1: Finned tube baseboard 2: FAN coil 3: Cast iron baseboard 4: Low mass radiant 5: High mass radiant 6: Radiator 7: Custom (set by installer)

Display	Description
	Boost interval time (set by installer)
	Space heating water pressure in PSI
	DHW priority time
	System supply water temperature (°F) (with optional temperature sensor)
	System return water temperature (°F) (with optional temperature sensor)

To exit the Information mode, press the Reset button.

### 3.4 Resetting the Boiler

If an error message appears, you can try resetting the boiler to resolve the problem. To reset the boiler, press the Reset button.

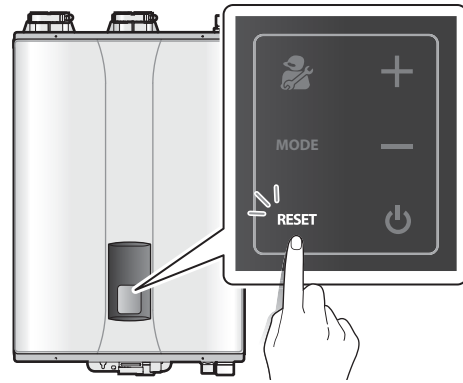

If resetting the boiler does not solve the problem, refer to the Troubleshooting section of this manual or contact Technical Support at 1-800-519-8794.

## 4. Maintaining the Boiler

### 4.1 Cleaning the Boiler

#### ! CAUTION

Make sure the boiler is turned off and the power supply is disconnected before cleaning the boiler. The boiler may remain hot for several minutes after it is turned off. To prevent burns, wait until the boiler has cooled down before cleaning.

To clean the boiler, wipe the outside with a damp cloth. Use a non-acidic, non-abrasive cleaner to remove any surface stains. The front panel is moisture resistant, but it is not waterproof. Keep it as dry as possible.

### 4.2 Draining the Boiler

You will need to drain the boiler before performing maintenance tasks, such as to prevent the boiler from freezing when it will not be used for an extended period.

Refer to “2.2 Parts of the Boiler” on page 6 for details about part locations.

To drain the boiler:

1. Place a bucket under the boiler to collect the residual water inside the boiler.
2. Press the Power button on the front panel to turn off the boiler.

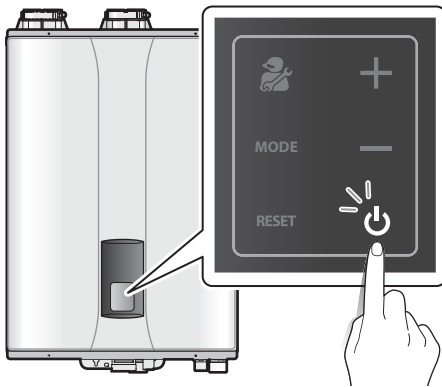

3. Close the gas valve.

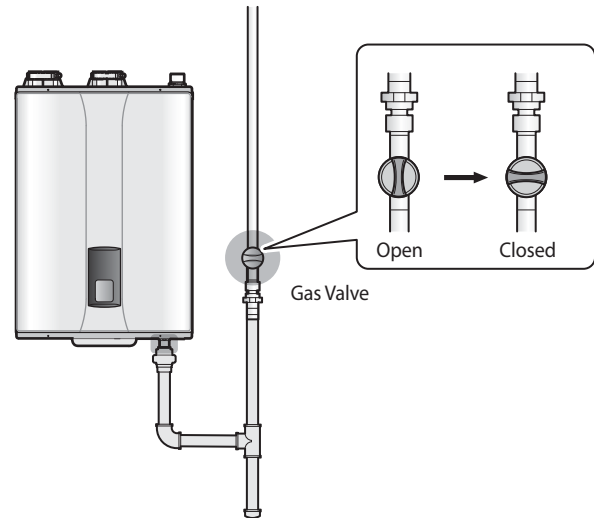

4. Close the water supply valve and the return valves on the manifold system.

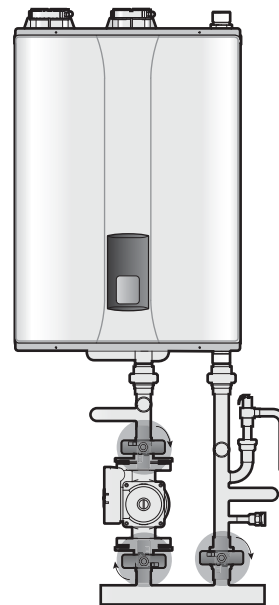

- Remove the drain cap on the manifold system to drain the boiler.

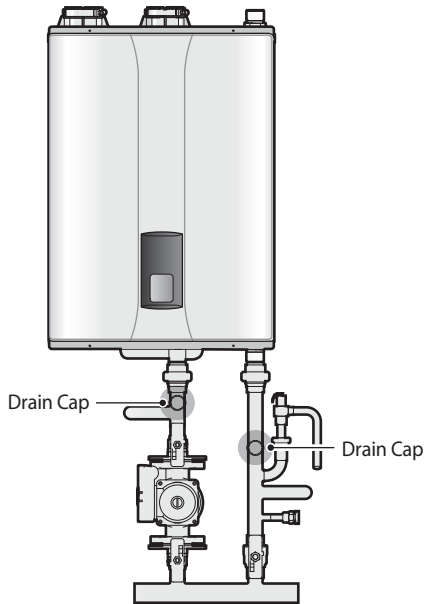

**Note**

- Place a bucket under the boiler to gather water released from the manifold system.
- Do not allow the pump to become wet.

### 4.3 Cleaning the Air Intake Filter

If the air intake filter becomes clogged by dust or lint, the boiler will cease to operate and "Error Code 110" will appear on the front panel display. To properly maintain the boiler, clean the air intake filter every 3-4 months.

To clean the air intake filter:

- Press the Power button on the front panel to turn off the boiler.

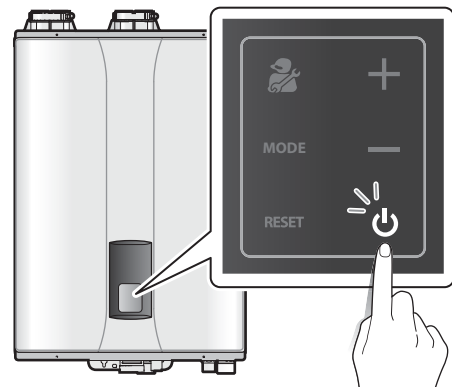

- Disconnect the power supply to the boiler.
- Remove the front cover of the boiler.

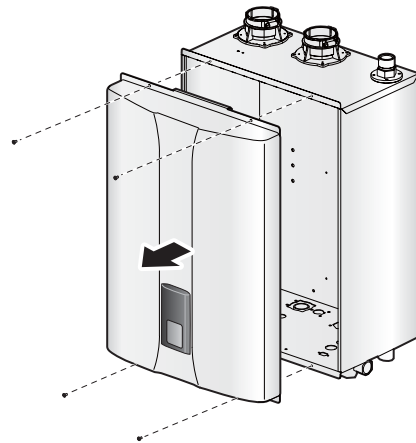

4. Remove the screw that secures the air intake filter (the filter is located at the top left of the boiler).

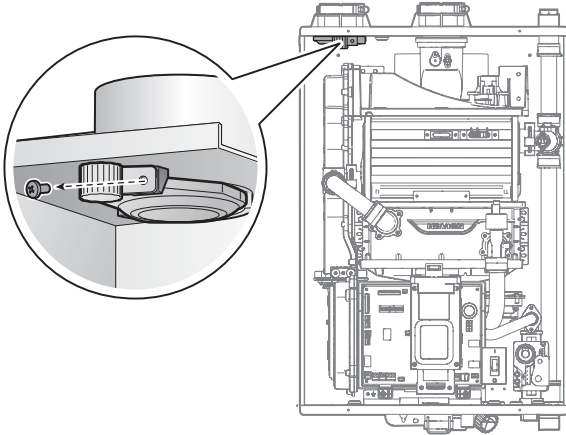

5. Pull the filter out of the boiler.

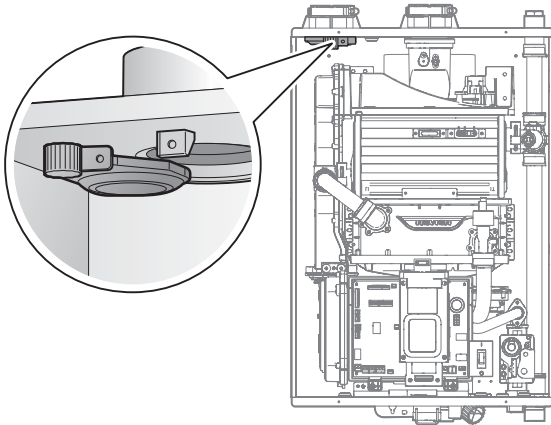

6. Remove the filter from the plastic assembly. Dust and rinse it with clean running water.



7. Allow the filter to dry completely.
8. Place the filter assembly back into the boiler and secure it with the screw.
9. Replace the front cover.
10. Reconnect the power supply to the boiler.
11. Press the Power button on the front panel to turn on the boiler.

## 4.4 Protecting the Boiler from Freezing

### CAUTION

Damage due to freezing is not covered by the Navien limited warranty.

- Freezing damage is most likely to occur due to back drafting caused by negative pressure in the building. This is not a manufacturing defect, and therefore, Navien will not warrant any damages due to freezing. The installer is responsible for ensuring that there is sufficient make-up air to avoid such a situation and the owner is responsible for ensuring that protection against freezing is maintained.
- To avoid freezing issues, we strongly recommend the use of a direct vent exhaust and intake system. Your installer should ensure that the exhaust vent pipe and the air intake pipe are both connected directly from the collars on the top of the boiler to the outdoors. This type of vent system minimizes air movement within the boiler.
- This boiler has an optional recirculation mode that is used for freeze protection. This mode should prevent the boiler from freezing, even if the intake air duct is not vented directly.
- The boiler is designed for indoor installation only.

To ensure that the boiler does not freeze, follow these guidelines:

- **Do not unplug the power supply cord**, except for routine maintenance. The boiler has a freeze protection function that requires electricity. The freeze protection function will operate regardless of whether or not the power is turned on or off, as long as the electric supply is still connected.
- **Do not close the gas valve**, except for routine maintenance, as this will limit additional freeze protection.
- **If the boiler will not be used for an extended period, drain the boiler.**

If the power or gas supplies must be disconnected for an extended period, drain the boiler. Freezing damage may occur if there is water remained in the boiler in cold weather.

If hot water will not flow and you suspect that the boiler is frozen, follow these steps:

1. Press the Power button on the front panel to turn off the boiler. Close the gas valve.

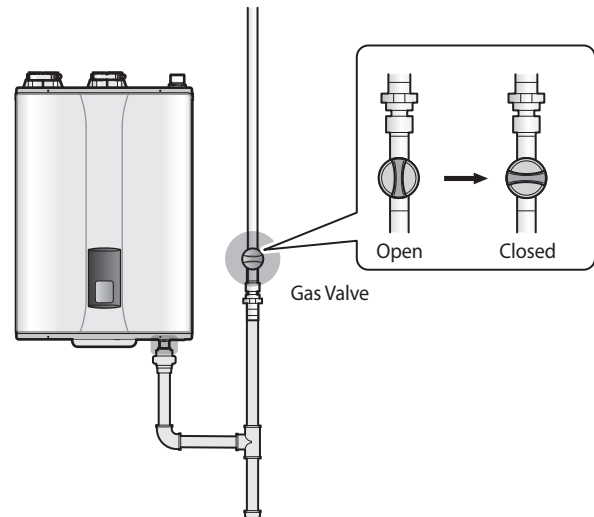

2. Open the hot water faucet that is closest to the boiler.
3. Use a hair dryer or a portable electric heater to heat up both the primary and secondary Heat Exchangers.
4. Check every few minutes to see if water is running at the open faucet.

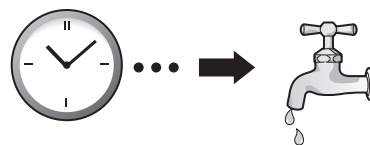

5. When the water starts flowing again, check the boiler and piping for leaks. If you detect any leaks or the boiler is not operating properly, contact an authorized technician or licensed professional.

### Note

This boiler requires very little maintenance, however a qualified technician should inspect the boiler at the beginning of every heating season and/or when there is a problem.

### CAUTION

If the unit will not be used immediately, close off all gas and water shutoff valves, drain all of the water out of the unit and the plumbing system to prevent the unit and system from freezing, and bleed the gas out of the gas line.

## 4.5 Maintenance Schedules

Regular maintenance is required to operate the boiler safely. Refer to the maintenance schedules below for proper maintenance of the boiler.

Owner maintenance	
Daily	<ul style="list-style-type: none"> <li>• Check the boiler area is free of combustible/flammable materials and air contaminants.</li> <li>• Check the pressure/temperature gauge for signs of higher than normal pressure.</li> </ul>
Monthly	<ul style="list-style-type: none"> <li>• Visually inspect the vent piping for signs of leakage and blockage.</li> <li>• Visually inspect the burner flames.</li> <li>• Inspect the condensate trap and the PVC fittings.</li> </ul>
Periodically	<ul style="list-style-type: none"> <li>• Test the LWCO for proper operation.</li> </ul>
Every 6 months	<ul style="list-style-type: none"> <li>• Inspect boiler piping (gas and water) for leaks.</li> <li>• Test to make sure the relief valve is operating normally.</li> </ul>
Non-heating season	<ul style="list-style-type: none"> <li>• Shut boiler down (unless boiler is used for domestic hot water).</li> </ul>

Service technician (See the following instructions)	
Annual Start-up	<p>General:</p> <ul style="list-style-type: none"> <li>• Address reported problems.</li> <li>• Inspect interior; clean and vacuum if necessary.</li> <li>• Clean condensate trap and fill with fresh water.</li> <li>• Check for leaks (water, gas, flue, condensate).</li> <li>• Verify flue and air lines in good condition and sealed tight.</li> <li>• Check system water pressure/system piping/expansion tank.</li> <li>• Check control settings.</li> <li>• Check ignition and flame rod (clean and reposition).</li> <li>• Check wiring and connections.</li> <li>• Inspect flame (stable, uniform).</li> <li>• Inspect flame signal.</li> </ul> <p>If combustion or performance indicate need:</p> <ul style="list-style-type: none"> <li>• Flush heat exchanger.</li> <li>• Remove and clean air intake filter.</li> <li>• Remove and clean space heating strainer.</li> <li>• Remove and clean inlet water filter.</li> </ul>





## **WARNING**

- Follow the service and maintenance procedures given throughout this manual and in component literature shipped with the boiler. Failure to perform the service and maintenance could result in damage to the boiler or system.
- Failure to follow the directions in this manual and component literature could result in severe personal injury, death, or substantial property damage.
- The boiler must be inspected annually, preferably at the start of the heating season, by a qualified service technician. In addition, the maintenance and care of the boiler must be performed to assure maximum boiler efficiency and reliability. Failure to service and maintain the boiler and system could result in equipment failure.
- Electrical shock hazard – Turn off power to the boiler before any service operation on the boiler except as noted otherwise in this instruction manual. Failure to turn off electrical power could result in electrical shock, causing severe personal injury or death.
- After each act of maintenance or servicing, proper operation of the boiler must be verified by a qualified service technician.

### **Addressing the Reported Problems**

Inspect any problems reported by the owner and correct before proceeding.

### **Inspecting the Installation Area**

1. Verify that boiler area is free of any combustible materials, gasoline and other flammable vapors and liquids.
2. Verify that air intake area is free of any of the contaminants listed in Installation & Operation Manual. If any of these are present in the boiler intake air vicinity, they must be removed. If they cannot be removed, reinstall the air and vent lines per the Installation and Operation Manual.

### **Inspecting the Boiler Interior**

1. Remove the front cover and inspect the interior of the boiler.
2. Vacuum any sediment from inside the boiler and components. Remove any obstructions.

### **Cleaning the Condensate Trap**

1. Inspect the condensate drain line, condensate fittings, and condensate trap.
2. Remove any sediment in the trap.
3. Fill with fresh water until the water begins to pour out of the drain.

### **Checking all Piping for Leaks**

Eliminate all system or boiler leaks. Continual fresh makeup water will reduce boiler life. Minerals can build up in sections, reducing heat transfer, overheating heat exchanger, and causing heat exchanger failure. Leaking water may also cause severe property damage.

1. Inspect all water and gas piping and verify to be leak free.
2. Look for signs of leaking lines and correct any problems found.

### **Checking the Flue Vent System and Air Piping**

1. Visually inspect the entire flue gas venting system and air piping for blockage, deterioration or leakage. Repair any joints that show signs of leakage. Verify that air inlet pipe is connected and properly sealed (if installed).
2. Verify that boiler vent discharge and air intake are clean and free of obstructions.



## **WARNING**

- Failure to inspect for the above conditions and have them repaired can result in severe personal injury or death.
- Do not operate the boiler if the intake or exhaust pipe is displaced, has holes, is clogged, or is corroded.

### Checking the Water System

1. Verify all system components are correctly installed and operational.
2. Check the cold fill pressure for the system. Verify it is correct (must be a minimum of 12 psi).
3. Watch the system pressure as the boiler heats up (during testing) to ensure pressure does not rise too high.

- Note**
- If the system contains glycol, test for proper concentration as recommended by manufacturer.
  - Excessive pressure rise indicates expansion tank sizing or performance problem.

4. Inspect automatic air vents and air separators. Remove air vent caps and briefly press push valve to flush vent.
5. Replace caps. Make sure vents do not leak. Replace any leaking vents.

### Checking Expansion Tank

- Expansion tanks provide space for water to move in and out as the heating system water expands due to temperature increase or contracts as the water cools.
- Perform annual checks as recommended by manufacturer to ensure proper operation.

### Checking the Pressure Relief Valves

Inspect the relief valve and lift the lever to verify flow. Before operating any relief valve, ensure that it is piped with its discharge in a safe area to avoid severe scald potential.



#### **WARNING**

##### **Explosion Hazard**

A dripping or leaking pressure relief valve must be replaced. Do not plug or remove the valve. Failure to follow these instructions can result in fire or explosion, and personal injury or death.

- Note**
- Safety relief valves should be inspected **at least once every three years**, by a licensed plumbing contractor or authorized inspection agency, to ensure that the product has not been affected by corrosive water conditions and to ensure that the valve and discharge line have not been altered or tampered with illegally.



#### **WARNING**

- Certain naturally occurring conditions may corrode the valve or its components over time, rendering the valve inoperative. Such conditions are not detectable unless the valve and its components are physically removed and inspected. This inspection must only be conducted by a plumbing contractor or authorized inspection agency – not by the owner. Failure to re-inspect the boiler relief valve as directed could result in unsafe pressure buildup, which can result in severe personal injury, death, or substantial property damage.
- Following installation, the valve lever must be operated **at least once a year** to ensure that waterways are clear. Certain naturally occurring mineral deposits may adhere to the valve, rendering it inoperative. When manually operating the lever, water will discharge and precautions must be taken to avoid contact with hot water and to avoid water damage.
- Before operating lever, check to see that a discharge line is connected to this valve directing the flow of hot water from the valve to a proper place of disposal. Otherwise severe personal injury may result. If no water flows, valve is inoperative. Shut down the boiler until a new relief valve has been installed.

After following the above warning directions, if the relief valve weeps or will not seat properly, replace the relief valve. Ensure that the reason for relief valve weeping is the valve and not over-pressurization of the system due to expansion tank waterlogging or undersizing.

### Inspecting the Ignition and Flame Detector Electrodes

1. Remove the ignition and flame detector electrodes from the boiler heat exchanger.
2. Remove any deposits accumulated on the ignition/flame detector electrode. If the electrodes cannot be cleaned satisfactorily, replace with new ones.
3. Replace ignition/flame detector electrode, making sure gasket is in good condition and correctly positioned.

### Checking the Ignition Ground Wiring

1. Check that the ground wire is in good condition and securely attached to the boiler casing.
2. Check ground continuity of wiring using continuity meter.
3. Replace ground wires if ground continuity is not satisfactory.

### Checking all Boiler Wiring

Inspect all boiler wiring, making sure wires are in good condition and securely attached.

### Checking the Control Settings

1. From the front panel, enter the Diagnostics Mode and check all settings. Adjust settings if necessary.
2. Check settings of external limit controls (if any) and adjust if necessary.

### Performing Start-up and Checks

1. Start boiler and make sure that the boiler is operating properly.
2. Verify cold fill pressure is correct and that operating pressure does not go too high.

### Check the Burner Flame

1. Inspect flame through observation window.
2. If the flame is unsatisfactory at either high fire or low fire, check for obstructions in the venting and ensure that the air intake filter is clean.

### Review with the Owner

1. Review the User's Information Manual with the owner.
2. Emphasize the need to perform the maintenance schedule.
3. Remind the owner of the need to call a licensed contractor should the boiler or system exhibit any unusual behavior.
4. Remind the owner to follow the proper shutdown procedure and to schedule an annual start-up at the beginning of the next heating season.

### Flushing the Heat Exchanger



#### **CAUTION**

Flushing the heat exchanger is a somewhat complicated procedure. Read the following instructions carefully before attempting this procedure. If you are uncertain about any of the steps in the procedure, contact an authorized technician or licensed professional. Keep in mind that improper maintenance can void your warranty.

Refer to the "2.2 Parts of the Boiler" on page 6 for details about part locations.

Before flushing the Heat Exchanger, gather the following items:

- A bucket that is 5 gallons or larger
- Cleaning solution diluted with water
- 3 hoses
- A water circulation pump
- 2 flush valves (if not installed)

#### **Note**

Before flushing the heat exchanger, additional flush valves ("A" and "B") must be installed on the near boiler piping (included with Navien Manifold System).

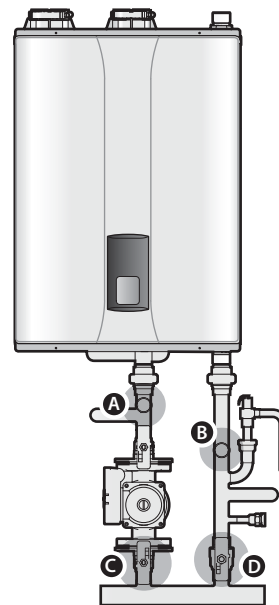

To flush the Heat Exchanger:

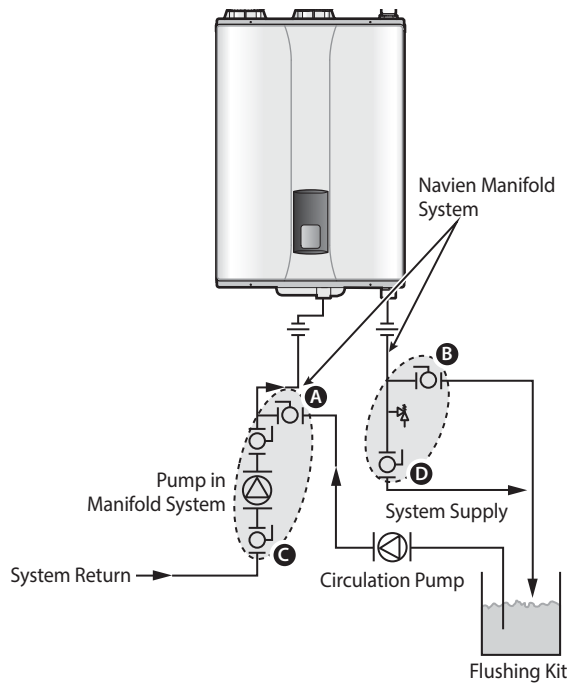

1. Press the Power button on the front panel to turn off the boiler.
2. Disconnect the power supply to the boiler.
3. Close the "C" and "D" valves on the supply and return water lines.
4. Connect one tube to the "B" valve and place the free end in the bucket.
5. Connect one of the tubes to the circulation pump outlet and the return water line at the "A" valve.
6. Connect one tube to the circulation pump inlet and place the free end in the bucket.
7. Pour the cleaning solution into the bucket.
8. Open both "A" and "B" valves.
9. Turn on the circulation pump and allow the solution to circulate through the boiler. Refer to the manufacturer's literature for information about the circulation time.
10. Rinse the cleaning solution from the boiler:
  - a. Remove the free end of the drain tube from the bucket and place it in the condensate drain or laundry tub (wherever the boiler drains).
  - b. Close the "A" valve and open the "C" valve. Do not open the "D" valve yet.
  - c. Allow water to flow through the boiler for 5 minutes.
  - d. Close the "B" valve and open the "D" valve.
11. Disconnect all tubes and valves.
12. Reconnect the power supply to the boiler.
13. Press the Power button on the front panel to turn on the boiler.

## 5. Troubleshooting

### 5.1 Solving Basic Problems

If you experience a problem with the boiler, refer to the following chart for possible remedies. Error codes that appear on the front panel display are explained in the following section.

For minor problems, resetting the boiler may resolve the issue. To reset the boiler, press the Reset button on the front panel.

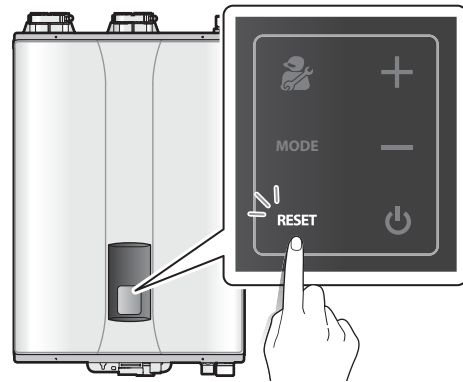

If resetting the boiler and attempting the remedies suggested below do not resolve the problem, contact an authorized technician, a licensed professional, or Technical Support at 1-800-519-8794 for service instructions.

Problem	Possible Cause(s)	What to do
Space heating side malfunction	Is the setting temperature too low?	Check the boiler's temperature setting. See "3.2 Adjusting the Temperature" on page 9.
	Is there power to the system, or is the system in stand by?	Make sure the power is on, and plugged into the outlet with the correct voltage. Press the Power button and raise the setting temperature. Make sure the boiler is turned on.
	Is the system running for domestic hot water (DHW)?	When the unit is heating for DHW, the heating side does not work.

## 5.2 Understanding Error Codes

When an error code appears on the front panel, refer to the following chart for a definition and possible remedy for the situation.

Error Code	Reason	Self-diagnostic/Action
E001	Heat exchanger over temperature	Auto reset/Manual reset/Power On reset
E003	Ignition failure	Manual reset/Power On reset
E004	False flame detection	Auto reset
E012	Flame loss	Manual reset/Power On reset
E016	Heat exchanger overheat	Manual reset/Power On reset
E030	Abnormal operation: exhaust temperature	Auto reset/Manual reset/Power On reset
E046	Abnormal operation: heat exchanger overheating sensor	Auto reset
E047	Abnormal operation: exhaust thermostat	Auto reset/Manual reset/Power On reset
E060	Abnormal operation: dual venturi	Alarm
E109	Abnormal operation: fan motor	Manual reset/Power On reset
E110	Exhaust vent closed	Manual reset/Power On reset
E205	Abnormal operation: heating supply thermistor	Auto reset
E218	Abnormal operation: heating return thermistor	Alarm
E271	Temperature differential limit	Alarm
E278	Abnormal operation: system supply thermistor	Alarm
E279	Abnormal operation: system return thermistor	Alarm
E291	Supply/Return inversion limit	Manual reset/Power On reset
E302	Low water pressure	Manual reset
E352	High water pressure	Auto reset
E353	Abnormal operation: water pressure sensor	Auto reset
E515	Abnormal operation: PCB component	Alarm/Manual reset/Power On reset
E517	Abnormal operation: DIP switch setting (PCB)	Manual reset/Power On reset
E594	Abnormal operation: EEPROM (PCB)	Alarm
E615	Abnormal operation: MCU	Alarm/Auto reset/Manual reset/Power On reset
E736	Abnormal operation: Cascade communication	Alarm
E740	Abnormal operation: outdoor temperature sensor	Alarm
E777	Abnormal operation: LWCO limit (external device)	Auto reset
E782	Abnormal operation: boiler communication	Alarm
E784	Abnormal operation: zone controller communication (external device)	Alarm

If these remedies do not resolve the problem, contact Technical Support at 1-800-519-8794.

# LIMITED WARRANTY NAVIEN, INC.

## Effective

This 10/15 year limited pro-rated warranty on heat exchangers, 3/5 year limited warranty on parts, and 1 year limited-labor warranty ("Warranty") covers defects in materials or workmanship when the Navien NHB Boiler ("Product") is installed by a properly licensed plumber or contractor and operated in strict compliance with the Installation & Operations manual procedures, subject to the terms within this Warranty document. Improper installation or use will void this Warranty. This Warranty runs from date of installation and extends to the original purchaser and subsequent owners, but only while the Product remains at the site of the original installation. This Warranty includes both a limited and pro-rated warranty as set forth below.

## What is covered?

Subject to the foregoing terms, Navien will repair or replace the covered Product or any part or component that is defective in materials or workmanship for a period of five (5) years in regard to parts and up to ten (10) Years in regard to the heat-exchanger. Navien will pay labor charges for the repair subject to Navien's prior written approval and in accordance with Navien's schedule of approved labor allowances for a period of one (1) year from the date of installation. All repair parts must be genuine Navien parts. All repairs and replacements must be performed by an individual or servicing company that is properly licensed to do the type of repair.

When the Product is or has ever been used for anything other than single family residential application (hereinafter "Commercial") then the parts warranty will be reduced to three (3) years and the heat exchanger warranty to seven (7) years as indicated in the pro-rated portion of the warranty below.

During the applicable warranty period, replacement of the Product or components may be authorized by Navien only. Navien does not authorize any person or company to assume for it any obligation or liability in connection with the replacement of the Product or its components. If it is determined that repair or replacement of a part, under warranty, is not possible, the Product will be replaced with a new Product having at least the same BTU capacity as the product at issue. The replacement component or product will be warranted only for the unexpired portion of the applicable warranty period for the original component or Product.

The heat exchanger is covered by Navien's pro-rated limited Warranty for defects in material and workmanship at a cost to the customer equal to a percentage of the Manufacturer's Suggested Retail Price (MSRP), at the time the warranty claim is approved by Navien, as indicated in the following Coverage Table for Heat Exchangers Only. This pro-rated warranty only applies to the replacement of the heat exchanger and does not include labor, shipping, other parts, delivery or installation. In order to obtain this warranty, the customer must pay the applicable pro-rated amount as indicated in the following Coverage Table for Heat Exchangers Only. Once the customer pays the pro-rated amount, then Navien will ship the heat exchanger directly to the service provider.

Coverage Table for Labor and Parts Only			
Residential*		Commercial	
Labor	1 year	Labor	1 year
Parts	5 years	Parts	3 years

\* Applies only to single family, residential locations.

Coverage Table for Heat Exchangers Only			
Residential*		Commercial	
Years	Percentage Paid by Customer	Years	Percentage Paid by Customer
1 to 10	0 %	1 to 7	0 %
11	30 %	8	50 %
12	40 %	9	60 %
13	50 %	10	70 %
14	60 %		
15	70 %		

\* Applies only to single family, residential locations.

## How do I get service?

You must contact the original installer of your Product. Your installer will need to contact Navien to report the issue. If the original installer cannot be identified or you no longer choose to use that service provider, you may choose any service provider who is properly licensed to complete the necessary repair. The installer and/or service provider must comply with Navien's warranty service and return policy procedures as available on Navien's website including contacting Navien's Technical Support Department at (800) 519-8794, option 2, prior to commencing any service.

Proof of the date of installation must be provided to Navien. At Navien's request, the defective Product or part must be returned to Navien. When the Product is installed in new construction, the date of installation shall be established as the date upon which the end-user takes title to the real property. If proof of the installation date is unavailable, then six months after the date of manufacture will be used.

## What is not covered?

Navien's Limited Warranty shall be void in the event of an occurrence of any of the following:

- Improper installation, including but not limited to, installation in violation of applicable rules, laws or building codes, inadequate water quality, condensate damage, improper venting, incorrect gas type, water pressure, absence of a drain pan, improper conversion from Natural Gas source to Propane, reinstallation at another location, etc.
- Accident, abuse or misuse including but not limited to installation for non-recommended uses, failure to follow or comply with the User's Operational Manual, etc.
- Improper maintenance including but not limited to, scale buildup, vent blockage, failure to maintain, etc.
- Modification, alteration, addition of non-approved components, or misapplication of the Product in any manner.
- Any damage caused by local adverse conditions including but not limited to water quality, hard water deposits, lime or mineral build-up, operating in corrosive atmospheric elements, alterations in smell or taste of water that have an adverse reaction on the unit, etc.
- Damage or problems caused by gas flow issues, electrical surges, flooding, fire, freezing, abnormal external temperature, force majeure, riot, act of war, or any acts of God.
- Performance problems caused by improper sizing of the boiler, the gas supply line, the venting connection, combustion air openings, electric service voltage, wiring, fusing or any other components, parts or specifications.
- Vibration and noise unless caused by a defect in materials or workmanship. Any other causes other than defects in materials or workmanship.
- Operating the Product at water temperatures outside the factory calibrated temperature limits and/or exceeding the maximum setting of the high limit control.
- Subjecting the heat exchanger to pressures or firing rates greater or lesser than those shown on the rating plate or removal of or alteration to the rating plate.
- Installation at any location outside the United States or Canada.
- Improper conversion from natural gas to liquid propane gas or liquid propane gas to natural gas or attempt to operate with a type of gas not specified for the boiler.
- Accidental or intentional damage.

There is no warranty on any Product purchased through the internet or from any installer that obtained the Product from a supplier or distributor not authorized by Navien.

## Warranty Limitations

EXCEPT AS EXPRESSLY PROVIDED HEREIN, THERE ARE NO OTHER WARRANTIES, EXPRESSED OR IMPLIED, INCLUDING, BUT NOT LIMITED TO WARRANTIES OR MERCHANTABILITY OR FITNESS FOR A PARTICULAR PURPOSE, WHICH EXTEND BEYOND THE DESCRIPTION OF THE WARRANTY HEREIN AND FURTHER NAVIEN SHALL NOT BE LIABLE FOR INDIRECT, INCIDENTAL, SPECIAL, CONSEQUENTIAL, PUNITIVE OR OTHER SIMILAR DAMAGES THAT MAY ARISE, INCLUDING LOST PROFITS, DAMAGE TO A PERSON OR PROPERTY, LOSS OF USE, INCONVENIENCE, OR LIABILITY ARISING FROM IMPROPER INSTALLATION, SERVICE OR USE OF THE PRODUCT. ANY IMPLIED WARRANTIES OF MERCHANTABILITY AND FITNESS ARISING UNDER STATE LAW ARE LIMITED IN DURATION TO THE PERIOD OF COVERAGE PROVIDED BY THIS WARRANTY, UNLESS THE PERIOD PROVIDED BY STATE LAW IS LESS.

No one is authorized to make any other warranties on behalf of Navien. Some states do not allow the exclusion or limitation of incidental or consequential damages, or how long an implied warranty lasts, so the above limitation may not apply to you.

This Limited Warranty gives you specific legal rights and you may also have other rights which vary from state to state.



# Notes

---



# User's Information Manual

## NHB Condensing Boilers

### Getting Service

If your boiler requires service, you have several options for getting service:

- Contact Technical Support at 1-800-519-8794 or on the website: [www.navien.com](http://www.navien.com).
- For warranty service, always contact Technical Support first.
- Contact the technician or professional who installed your boiler.
- Contact a licensed professional for the affected system (for example, a plumber or electrician).

When you contact Technical Support, please have the following information at hand:

- Model number
- Serial number
- Date purchased
- Installation location and type
- Error code, if any appears on the front panel display.

Version: 2.0 (May 30, 2019)



800.519.8794 | [www.Navien.com](http://www.Navien.com)  
20 Goodyear Irvine, CA 92618