

- Certified design according to **ANSI Z21.10.3 - CSA 4.3-2** latest standards for both indoor or outdoor installations (with optional Pipe Cover Kit or Recess Box)
- Compatible with **3/5" Category III Concentric** vent up to **20 ft**** (**with no elbows)
- Designed for use in **Residential** and **Commercial** applications (see below for available models and warranty terms)
- Gas Input Range
NHW700-160A(I,E), NHW700-160S(U,E) - 160,000 to 10,700 BTU/h
NHW700-180A(I,E), NHW700-180S(U,E) - 180,000 to 10,700 BTU/h
NHW700-199A(I,E), NHW700-199S(U,E) - 199,900 to 10,700 BTU/h
- Hot Water Flow Rate Capacity (*based on 45°F temperature rise)
NHW700-160A(I,E), NHW700-160S(U,E) - 5.8 GPM
NHW700-180A(I,E), NHW700-180S(U,E) - 6.6 GPM
NHW700-199A(I,E), NHW700-199S(U,E) - 7.4 GPM
- **ComfortFlow Technology** – Built-in recirc pump and buffer tank with advanced recirculation programming including: Always On, Weekly, an Intelligent modes (NHW700-A Series ONLY)
- **Built-in Control Panel** - allows adjustment of temperature settings and displays the operating status and error codes
- **Temperature Options** - available temperature settings for various applications range from 98°F up to 140°F
- **Ready-Link Cascade Compatible** for up to 2 units for increased hot water production
- Compatible with Navilink and Navilink Lite Wi-Fi Control (#PBCM-AS-001/2)
- **Freeze Protection** - maintains normal operations in cold weather conditions when the unit is installed INDOORS and connected to power. For OUTDOOR installations: the ambient temperature at the installation location must be 32° F (0°C) and below 125°F (52°C) Note Refer to the Installation Manual for additional Freeze Protection guidelines
- **Uniform Energy Factor Ratings** for NG and LP units
NHW700-160A(I,E), NHW700-160S(U,E) - 0.81 UEF
NHW700-180A(I,E), NHW700-180S(U,E) - 0.81 UEF
NHW700-199A(I,E), NHW700-199S(U,E) - 0.81 UEF
- Models available for use with **Natural Gas (NG)** or **Propane (LPG)***** (***) can be field converted with optional Conversion Kit installed by a qualified service agency)
- Approved for Installations on **Mobile/Manufactured Homes**
- Certified by **CSA, NSF 5/Low Lead, AHRI, SCAQMD** (Rule 1146.2 Type 1 - Complies with 14 ng/J or 20 ppm NOx @ 3% O2)
- **15-Year** Heat Exchanger and **5-Year** Parts Warranty (Residential)**** **5-Year** Heat Exchanger and **5-Year** Parts Warranty (Commercial)**** (***) **includes 1-Year Labor warranty - see Navien Limited Warranty)**
- **Optional accessories** are available (see below)



Interior/Universal Concentric Direct Vent
INDOOR use (Universal: Outdoor use requires Vent Cap)





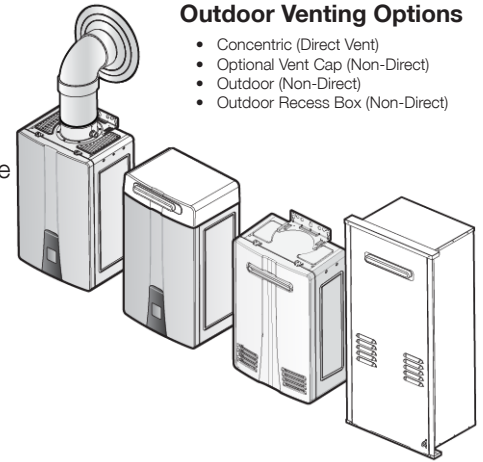

Exterior - Non-Direct Vent
OUTDOOR use only

Indoor/Universal and Outdoor Venting Options

- Concentric (Direct Vent)
- Optional Vent Cap (Non-Direct)
- Outdoor (Non-Direct)
- Outdoor Recess Box (Non-Direct)

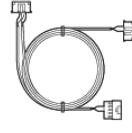
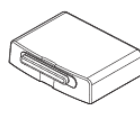

Job Name: _____
Location: _____
Engineer: _____
Wholesaler: _____
Contractor: _____
Model No.: _____
Submitted to: _____

| | | | | | | |
|---|---|---|---|--|---|---|
|  |  |  |  |  |  |  |
| <p>Plumb Easy Value Set (V2) 3/4" with Relief Valve (GXXX002139)</p> | <p>Recess Box (Outdoor Only) NHW-SE (30023550A) NHW-AE (30032303A)</p> | <p>Pipe Cover NHW-SU/SE: (30024017A) NHW-AI/AE: (30032304A)</p> | <p>Navilink Wifi Control (PBCM-AS-001) Navilink Lite (PBCM-AS-002)</p> | <p>Remote Controller NR-21DU (30022717B)</p> | <p>Ready-Link Communication Cable (GXXX000546)</p> | <p>Outdoor Vent Cap (Universal Only) NHW-SU: (30023991A)</p> |

From NHW-S QF Indoor Model

From NHW-A Spec Sheet

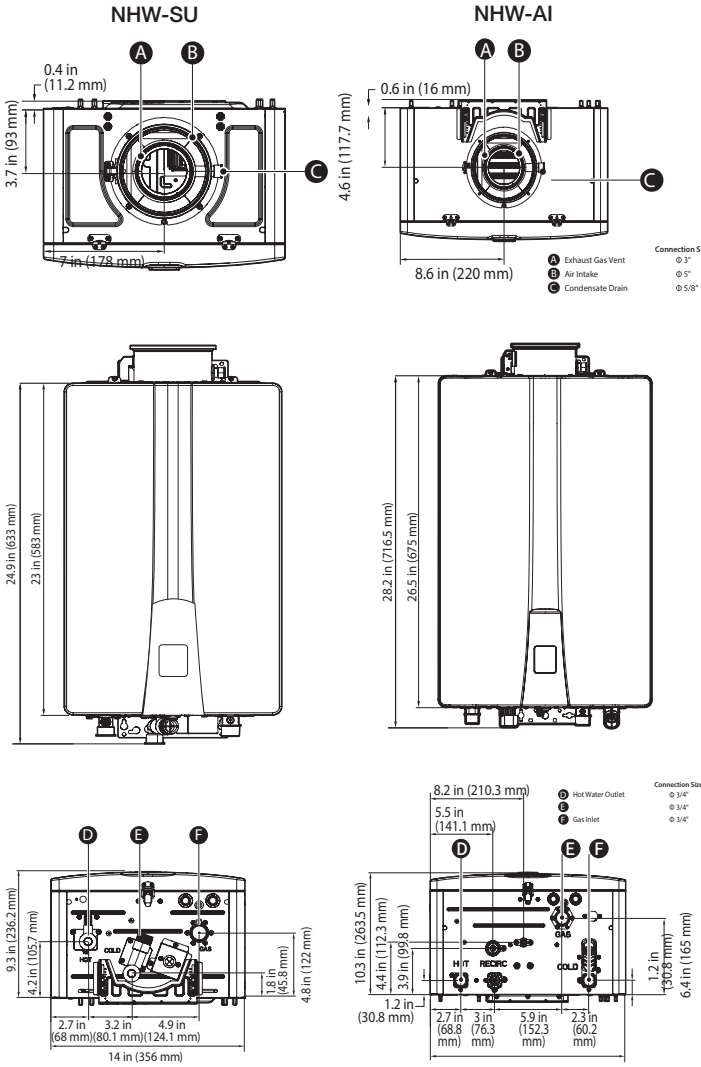

| Item | NHW700 Universal/Interior | | | | | | NHW700 Exterior | | | | | |
|---|---|---|--------------------------|----------------------|--------------------------|----------------------|--------------------------|----------------------|--------------------------|----------------------|--------------------------|----------------------|
| | 160SU | 160AI | 180SU | 180AI | 199SU | 199AI | 160SE | 160AE | 180SE | 180AE | 199SE | 199AE |
| Heat Capacity (Input) | Natural Gas | 10,700-160,000 BTU/H | | 10,700-180,000 BTU/H | | 10,700-199,900 BTU/H | | 10,700-160,000 BTU/H | | 10,700-180,000 BTU/H | | 10,700-199,900 BTU/H |
| | Propane Gas | | | | | | | | | | | |
| Uniform Energy Factor | UEF (for NG&LP) | 0.81 | 0.81 | 0.81 | 0.81 | 0.81 | 0.81 | 0.81 | 0.81 | 0.81 | 0.81 | 0.81 |
| Flow Rate (DHW) | 45 °F (25 °C) Temp Rise | 5.8 GPM (22 L/m) | | 6.6 GPM (25 L/m) | | 7.4 GPM (28 L/m) | | 5.8 GPM (22 L/m) | | 6.6 GPM (25 L/m) | | 7.4 GPM (28 L/m) |
| | 67 °F (36 °C) Temp Rise | 4.0 GPM (15 L/m) | | 4.5 GPM (17 L/m) | | 5.0 GPM (19 L/m) | | 4.0 GPM (15 L/m) | | 4.5 GPM (17 L/m) | | 5.0 GPM (19 L/m) |
| Dimensions | S Model: 14.0 in (W) x 23.0 in (H) x 9.3 in (D), A Model: 17.3 in (W) x 26.5 in (H) x 10.3 in (D) | | | | | | | | | | | |
| Weight (Gross) | 55 lbs (25 kg) | 68 lbs (31 kg) | 60 lbs (27 kg) | 72 lbs (33 kg) | 60 lbs (27 kg) | 72 lbs (33 kg) | 55 lbs (25 kg) | 71 lbs (32 kg) | 60 lbs (27 kg) | 75 lbs (34 kg) | 60 lbs (27 kg) | 75 lbs (34 kg) |
| Installation Type | Interior Model: Indoor Wall-Hung Only Universal Model: Indoor Wall-Hung (Vent Kit Required for Outdoor) | | | | | | Outdoor Wall-Hung Only | | | | | |
| Venting Type | Forced Draft Direct Vent (Universal/Interior Models Only) | | | | | | | | | | | |
| Ignition | Electronic Ignition | | | | | | | | | | | |
| Water Pressure | 15-150 PSI | | | | | | | | | | | |
| Natural Gas Supply Pressure (from source) | 3.5 in WC-10.5 in WC | | | | | | | | | | | |
| Propane Gas Supply Pressure (from source) | 8 in WC -13 in WC | | | | | | | | | | | |
| Natural Gas Manifold Pressure (Max.-Min.) | 2.8 in W.C., 0.7 in W.C. | | 2.3 in W.C., 0.7 in W.C. | | 2.8 in W.C., 0.7 in W.C. | | 3.2 in W.C., 0.8 in W.C. | | 2.6 in W.C., 0.8 in W.C. | | 3.2 in W.C., 0.8 in W.C. | |
| Propane Gas Manifold Pressure (Max.-Min.) | 5.8 in W.C., 1.3 in W.C. | | 4.5 in W.C., 1.3 in W.C. | | 5.4 in W.C., 1.3 in W.C. | | 6.1 in W.C., 1.4 in W.C. | | 4.9 in W.C., 1.3 in W.C. | | 6.0 in W.C., 1.3 in W.C. | |
| Minimum Flow Rate | 0.26 GPM (1.0 L/m), <0.01 GPM (0.04 L/m) options for "A" Models* | | | | | | | | | | | |
| Activation Flow Rate | 0.4 GPM (1.5 L/m) | | | | | | | | | | | |
| Connection Sizes | Cold Water Inlet | 3/4 in NPT | | | | | | | | | | |
| | Hot Water Outlet | 3/4 in NPT | | | | | | | | | | |
| | Gas Inlet | 3/4 in NPT | | | | | | | | | | |
| Power Supply | Main Supply | 120V AC, 60Hz | | | | | | | | | | |
| | Normal | 95W | 100W | 115W | 99W | 81W | 96W | | | | | |
| | Maximum Power Consumption | 120W (Max 2A) for Non-Pump Model, 350W (Max 4A) for A Model or S Model with External Pump Connected | | | | | | | | | | |
| | External Pump | <150W, 1.5A | | | | | | | | | | |
| Materials | Fuse | 5.0 A | | | | | | | | | | |
| | Cabinet | Cold Rolled Carbon Steel | | | | | | | | | | |
| Heat Exchangers | Stainless Steel | | | | | | | | | | | |
| Safety Devices | Flame Rod APS, Vent Installation Detector, Ignition Operation Detector, Water Temperature High Limit Switch, Power Surge Fuse | | | | | | | | | | | |

Gas-fired, tankless, non-condensing, wall-mounted water heater(s) shall be direct vent NHW700 Series models as manufactured by Navien, Inc. and are certified by CSA Group to the latest edition of ANSI standard Z21.10.3/CSA 4.3. Water heater(s) is designed for both Residential and Commercial applications and shall have a 15-year limited Heat Exchanger warranty and 5-year limited Parts warranty (5-year Heat Exchanger and 5-year Parts for Commercial use) with a 1-year Labor warranty per Navien Limited Warranty. Unit(s) shall be designed to use either natural gas or propane gas, please use correct gas type. Water heater(s) shall have a nominal flow rate capacity of GPM/GPH at °F rise with rated input of BTU/hr. Water heater(s) shall be vented with 3"x5" concentric vent pipe at a distance not to exceed 20' (or equivalent) with each elbow equal to 5' of pipe length. Water heater(s) is rated for 150 PSI working water pressure and 300 PSI test pressure. Gas supply pressure shall be 3.5" to 10.5" WC for natural gas and 8.0" to 13.0" WC for propane. Unit(s) shall have a steel case, stainless steel heat exchanger, power burner, gas valve, air pressure sensor, 3/4" inlet gas connection, 3/4" brass inlet/outlet water connections, water holding capacity of 0.5 gallons for the NHW700-160A, 0.7 gallons for NHW700-180A model, 0.9 gallons for NHW700-199A, excluding water in the buffer tank. The NHW700-160A weighs 68.0 lbs, and the NHW700-180A/NHW700-199A models weigh 72.0 lbs. Unit(s) shall include features such as an adjustment for installations at high elevation, temperature lockout, and temperature options from 98-140°F in 1°F intervals (36°C-60°C in 0.5°C intervals). The water heater(s) shall be controlled by an internal circuit board that monitors the inlet and outlet temperatures with installed thermistors, sensing and controlling flow rate to set point temperature in conjunction with the combustion controls in order to maintain thermal combustion efficiency. Unit(s) shall include safety features such as flame sensor system, high limit sensors, overheat prevention device, freeze protection mode, and fan motor rotation detector. 2-unit cascade applications shall be installed by connecting the units using cable-only connections (Ready-Link). The water heater(s) exceeds the energy efficiency requirements of ASHRAE 90.1-2013 and is listed by SCAQMD rule 1146.2 (Type 1) for Low NOx that complies with 14 ng/J or 20 ppm NOx requirements @ 3% O2.