

NFB-H Series



NFB-H High Capacity Condensing Fire Tube Boilers



Navien packs the highest levels of performance and hydronic heating technology into one compact boiler

NaviLink® Wi-Fi remote control system...available as an add-on accessory.



THE LEADER IN CONDENSING TECHNOLOGY

NFB-H NAVIEN CONDENSING FIRE TUBE HIGH CAPACITY BOILERS

Navien keeps raising the bar higher and higher in fire tube boiler innovations

We totally reinvented fire tube technology from the ground up and we continue to advance our boiler technology to a higher level with the new NFB-H boiler series.

- Patented stainless steel fire tube heat exchanger—reduces high stress point welds
- Advanced user interface with intuitive text display and Quick Dial Wheel for easy navigation
- Smart controls with Setup Wizard to simplify boiler start up
- Built-in 3 zone pumps or 3 zone valves powered connections
- Optional NaviLink® Wi-Fi remote control
- Common venting up to 8 boilers
- Cascading up to 16 boilers
- Up to 15:1 turndown ratio
- AFUE 95.0%—Energy Star certified
- Compact, light weight, wall hung design saves space over traditional floor standing boilers



Before



After



PATENTED
STAINLESS STEEL
FIRE TUBE HX

ADVANCED
USER INTERFACE

TDR UP TO
15:1

3 ZONES
VALVES or PUMPS

NG OR LP FIELD GAS
CONVERTIBLE

2" VENT UP TO 65 FEET & 3" VENT UP TO 150 FEET

ENERGY STAR
AFUE
95.0%

1/2" GAS CAPABILITY UP TO 24 FT



Navien's patented stainless steel fire tube heat exchanger with laser weld technology

Navien's advanced patented stainless steel heat exchanger is designed and manufactured in-house using robotic laser welding to deliver higher product quality. The ASME-Certified, "H" Stamped, design also reduces high stress point weld failures common on other boilers.

NFB-H's innovative heat exchanger design allows water to fill the entire heat exchanger which eliminates the need for the extra insulation at the top of the combustion chamber and improves durability.

EPP insulation used on the exterior of the heat exchanger reduces heat loss and increases efficiency.

Low profile burner design is easy to remove, improving serviceability. It also reduces the overall heat exchanger height, unlike the taller, bulkier competitive designs using cylindrical burners.

One-piece combustion chamber prevents corrosion at welding points. Reducing welds in the combustion chamber minimizes areas prone to corrosion.

New heat exchanger diaphragm design optimizes water flow and improves performance (patent pending).

Turbulators inside the tubes increase structural strength and at the same time create a cyclone effect of flue gases maximizing heat transfer rate and improving efficiency (patent pending).

Non-metallic drain pan prevents corrosion caused by acidic condensate, unlike competitors' metal drain pans.

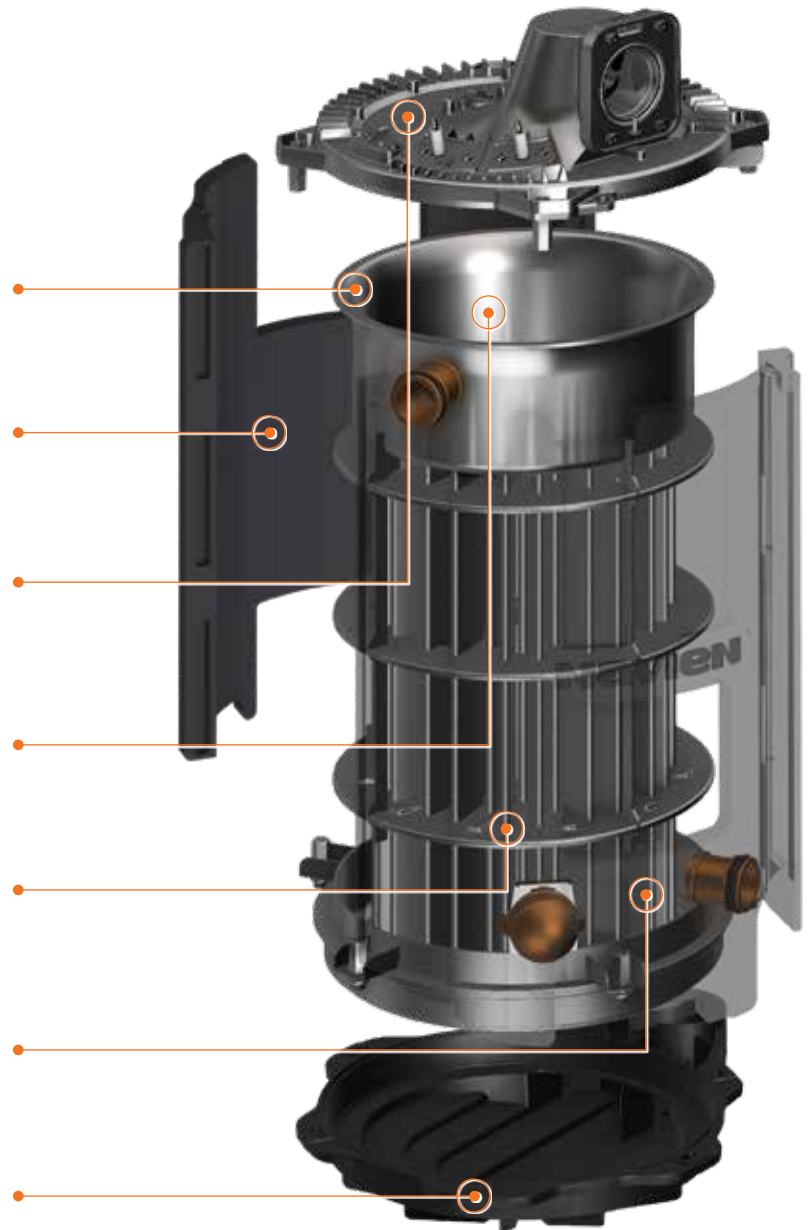

COMPARE THESE ADVANTAGES AND SEE WHY NFB-H BOILERS ARE THE PERFECT FIT FOR YOUR NEXT APPLICATION

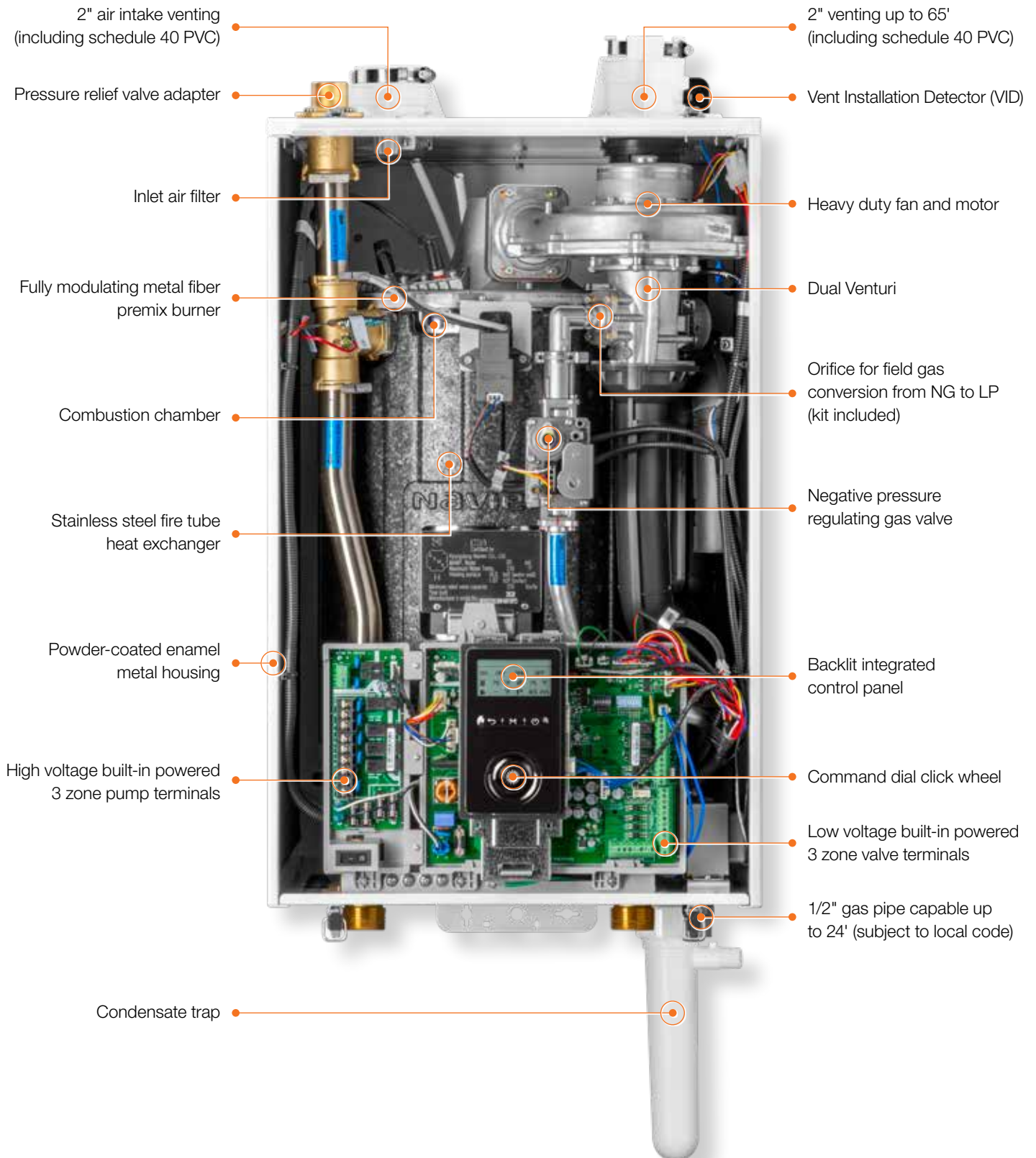

T H E L E A D E R I N C O N D E N S I N G T E C H N O L O G Y



Space saving and lighter weight design

The sleek wall-hung design uses much less space and is substantially lighter than traditional floor standing boilers, making installations a lot easier.



Uses existing 1/2" gas piping

Save time and effort in retrofit applications with 1/2" gas lines for up to 24' in length. Subject to local code.

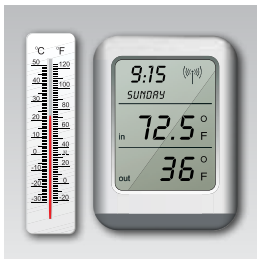

Up to 15:1 turndown ratio

The sophisticated gas flow control system provides a high turndown ratio which reduces energy waste and excessive boiler cycling.

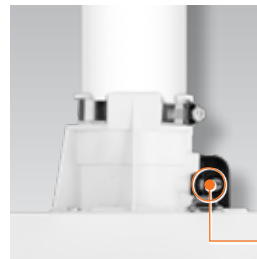

2" PVC venting up to 65', 3" up to 150'

Low exhaust gas temperatures allow use of PVC (including schedule 40 PVC), CPVC, polypropylene (rigid and flexible) and stainless steel venting saving time and costs.

Vent Installation Detector (VID) for added safety.



Low gas pressure operation

Negative pressure regulating gas valve ensures maximum performance all the way down to 3.5" of water column on natural gas and 8" of water column on propane gas.

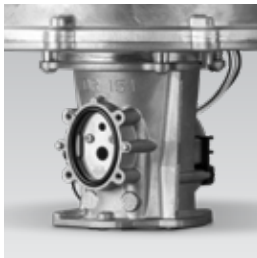

Dual Venturi and field gas convertibility

Dual Venturi system creates better combustion control and turndown ratio. Field gas convertibility is easy with orifice conversion kits for NG high altitude (5,400-10,100 ft.) and LP (up to 10,100 ft.) included with NFB-H Series boilers.



MORE REASONS TO CHOOSE NFB-H OVER TRADITIONAL FLOOR BOILERS



Optional Wi-Fi control

This add-on accessory will enable customers with smartphones and tablets to control temperatures remotely, access usage data and receive diagnostic notifications on NFB-H models.



NaviLink
PBCM-AS-001



NaviLink Lite
PBCM-AS-002



Optional magnetic filter

The NaviClean™ is designed to work with Navien combi-boilers and boilers. It is best suited for heating systems with 1" to 1-1/4" copper or black iron pipes. It features a permanent magnet mounted inside the glass reinforced nylon housing.

This powerful permanent magnet removes high levels of iron oxides, and the large canister design is for capturing sludge and debris. Its built-in inlet/outlet ports and low-profile drain valve make installation and service easier. Also, the large canister and full flow valves minimize pressure drop for maximum performance. High flex seals provide added protection against leaks. GXXX001727



In minutes, the NaviClean magnetic filter traps the iron oxide debris, and the water is clear



Common vent up to 8, cascade up to 16

With Navien's cascading technology, when a unit gets up to capacity determined by the supply and return temperatures, the next unit will start to help meet the hydronic space heating requirements. This boiler sequence will continue until all units are generating the needed hydronic space heat, up to the maximum cascaded capacity. The Navien cascading system also balances out the workload of each unit for longer life. The NFB-H is dual certified for direct and non-direct venting applications.





Additional accessories for NFB-H fire tube boilers



SmartZone+ pump controller

Zone pump controller designed to work with NFB-H series units allowing control up to 6 zone pumps. Adding the SmartZone control will also allow expansion of the built in NFB-H zoning.

2 Zones: PFMZ-02P-001

3 Zones: PFMZ-03P-001

4 Zones: PFMZ-04P-001

6 Zones: PFMZ-06P-001



2" common vent collar kit

Required for common vent installations with additional NFB-H boilers.

30014367B

Includes common vent collar damper, VID jumper cable and cascade cable (GXXX000546).



Ready-Link® communication cable

Required to cascade up to 16 NFB-H boilers.

GXXX000546



NFB-H primary manifold kit

Navien's NFB-H primary manifold kits are system matched for fast installations and maximum efficiency.

GFFM-MSOZUS-002



Universal temperature sensor

Designed to sense supply, return or tank water temperature. Works with all NFB-H series boilers.

GXXX001769

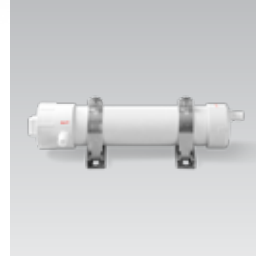

Light commercial neutralizer

Light commercial condensate neutralizer designed to neutralize the condensate for up to 6 NFB-H boilers

GXXX001324

Replacement media for light commercial neutralizer

GXXX001328



Residential neutralizer (V2)

Residential condensate neutralizer for NFB-H series units designed to neutralize the condensate for one NFB-H boiler.

GXXX002212

Replacement media for residential neutralizer

GXXX001323



Commercial neutralizer

Commercial condensate neutralizer for NFB-H series units designed to neutralize the condensate of up to 16 units.

GXXX001325

Replacement media for commercial neutralizer

GXXX001329



Ready-Link® rack base (V3) and add-on rack(s)

Base (V3)

GFFMKDIZUS-005

Add-on (V3)

GFFMKDIZUS-006

Dimensions Ratings & specifications

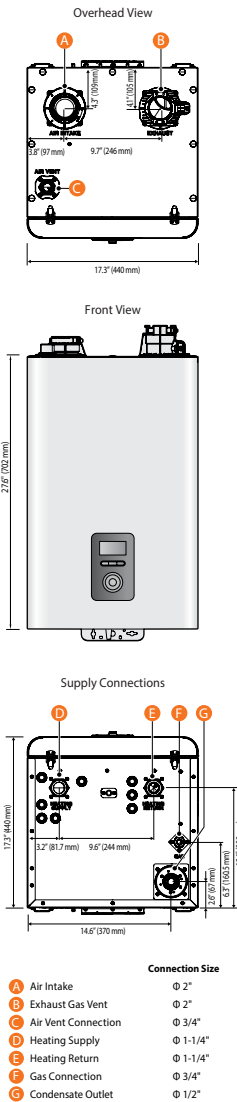

Navien Condensing Boiler Space Heating Ratings						Other Specifications		
Model Number ¹	Heating input (BTU/H)		Heating Capacity ² (BTU/H)	Net AHRI Rating Water ³ (BTU/H)	AFUE ^v %	Water Pressure	Water Connection Size (Supply, Return)	Water Volume
	Min	Max						
NFB-175H	13,300	175,000	160,000	139,000	95.0	6-80 psi	1-1/4" NPT	4.5 gallons
NFB-200H	13,300	199,900	182,000	158,000	95.0			

¹ Ratings are the same for natural gas models converted to propane use.
² Based on U.S. Department of Energy (DOE) test procedures.
³ The net AHRI water ratings shown are based on a piping and pickup allowance of 1.15.
 Consult Navien before selecting a boiler for installations having unusual piping and pickup requirements, such as intermittent system operation, extensive piping systems, etc.

Item	Model	
	NFB-175H	NFB-200H
Dimensions	17.3" W x 17.3" D x 27.6" H	
Boiler weight	121 lb (55 kg)	
Boiler weight with water	148 lb (67 kg)	
Installation type	Indoor wall-hung	
Venting type	Forced draft direct vent	
Ignition	Electronic ignition	
Natural Gas supply pressure (from source)	3.5" to 10.5" WC	
Propane Gas supply pressure (from source)	8.0" to 13.0" WC	
Natural Gas manifold pressure	-0.03" to -0.70" WC	-0.03" to -0.85" WC
Propane Gas manifold pressure	-0.02" to -0.68" WC	-0.02" to -0.75" WC
Gas connection size	3/4" NPT	
Power supply	Main supply	120V AC, 60Hz
	Maximum power consumption	Less than 15 amperes
Materials	Casing	Cold-rolled carbon steel
	Heat exchanger	Stainless steel
Venting	Exhaust	2" or 3" PVC, CPVC, approved polypropylene 2" or 3" special gas vent type BH (Class III, A/B/C) 2" or 3" stainless steel
	Intake	2" or 3" PVC, CPVC, polypropylene 2" or 3" special gas vent type BH (Class III, A/B/C) 2" or 3" stainless steel
	Vent clearance	0" to combustibles
Safety devices	Flame rod, APS, ignition operation detector, water temperature high limit switch, exhaust temperature high limit sensor, water pressure sensor, vent installation detector (VID)	

Navien reserves the right to change specifications at any time without prior notice.
 Please refer to Navieninc.com to verify you have the most current information.

Gas input ranges

Model	Range (BTU/H)	TDR
NFB-175H	13,300-175,000	13.2:1
NFB-200H	13,300-199,900	15:1

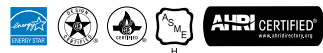

Warranty

Type	Residential*	Commercial
Heat exchanger	15 year limited warranty	10 years
Parts	5 years	3 years
Labor	1 year	1 year

*Applies to single family residential locations.
 For complete details please refer to the full warranty at Navieninc.com.

Navien Inc., 20 Goodyear, Irvine, CA 92618 800-519-8794 Navieninc.com
 Navien Canada, Inc. 555 Hanlan Rd., Unit 7 Vaughan, ON L4L 4R8 800-519-8794 navieninc.ca



THE LEADER IN CONDENSING TECHNOLOGY