

THIS DRAWING IS INTENDED ONLY AS A GUIDE AND NOT AS A REPLACEMENT FOR PROFESSIONALLY ENGINEERED PROJECT DRAWINGS. THIS CONCEPT SYSTEM DRAWING DOES NOT IMPLY COMPLIANCE WITH LOCAL BUILDING CODES. ACTUAL INSTALLATION MAY VARY DEPENDING ON INSTALLATION LOCATION AND PARAMETERS AND IT MUST BE DONE IN ACCORDANCE TO ALL LOCAL BUILDING CODES. VERIFY WITH LOCAL BUILDINGS OFFICIALS BEFORE COMMENCEMENT OF SYSTEM INSTALLATION. CHANGES OR MODIFICATIONS TO PIPING OR DESIGN IS NOT TO BE PERFORMED WITHOUT EXPRESSED WRITTEN PERMISSION BY NAVIEN, INC.

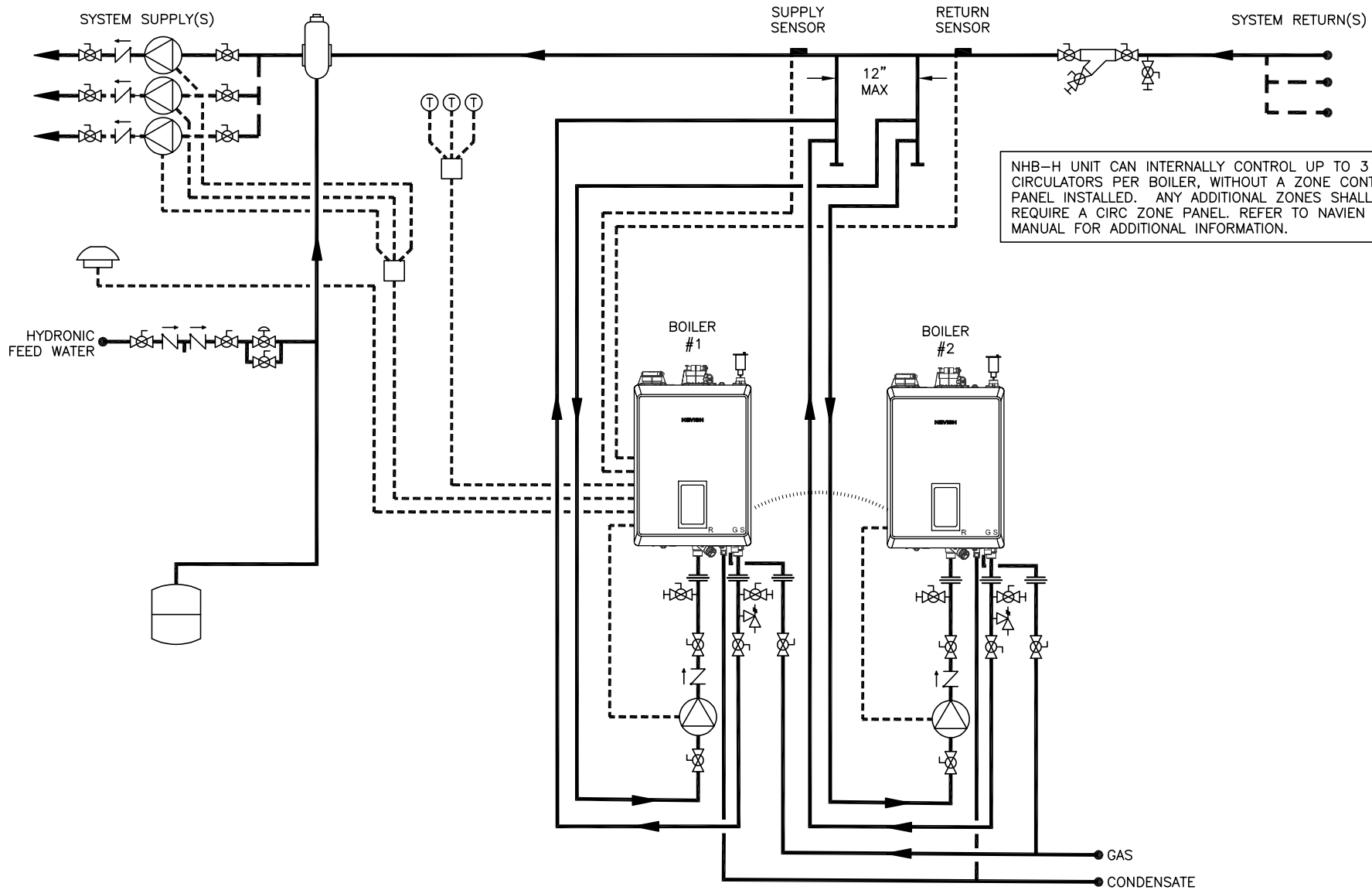

NHB-H UNIT CAN INTERNALLY CONTROL UP TO 3 ZONE CIRCULATORS PER BOILER, WITHOUT A ZONE CONTROL PANEL INSTALLED. ANY ADDITIONAL ZONES SHALL REQUIRE A CIRC ZONE PANEL. REFER TO NAVIEN I & O MANUAL FOR ADDITIONAL INFORMATION.

SYMBOL LEGEND			
	BACKFLOW PREVENTER		CHECK VALVE
	CONTROL WIRING		PRESSURE RELIEF VALVE
	OUTDOOR TEMPERATURE SENSOR		AIR ELIMINATION
	WYE STRAINER W/ BLOWDOWN		AUTOMATIC AIR VENT
	FULL-PORT VALVE		CIRCULATOR
	EXPANSION TANK		THERMOSTAT
	UNION		BALL DRAIN VALVE
	CASCADE CABLE		PRESSURE REDUCING VALVE



20 GOODYEAR
IRVINE, CA 92618
800-519-8794
www.navienc.com

NHB-H SERIES BOILER

(2) NHB-H BOILERS WITH
INDIVIDUAL SECONDARY INJECTION PIPING
INCLUDES MODELS NHB-110H, 150H

DRAWN BY: S. STOEKE

NHB-H-2-ZP-MULT-I

JANUARY 25, 2024