

User's Information Manual

NHW700 Non-Condensing Water Heaters

Model | NHW700-160SE/180SE/199SE
NHW700-160SU/180SU/199SU
NHW700-160AI/180AI/199AI
NHW700-160AE/180AE/199AE



* Lead Free

ALWAYS read and follow this manual completely before using the water heater. Save for future reference.
Tested and Certified to NSF/ANSI 372 for lead free* compliance.
* The wetted surface of this product contacted by consumable water contains less than one quarter of one percent (0.25%) of lead by weight.

WARNING

If the information in these instructions is not followed exactly, a fire or explosion may result, causing property damage, personal injury, or death.

Do not store or use gasoline or other flammable vapors and liquids in the vicinity of this or any other appliance.

WHAT TO DO IF YOU SMELL GAS

- Do not try to light any appliance.
- Do not touch any electrical switch; do not use any phone in your building.
- Immediately call your gas supplier from a neighbor's phone. Follow the gas supplier's instructions.
- If you cannot reach your gas supplier, call the fire department.

Installation and service must be performed by a qualified installer, service agency or the gas supplier.

The installation must conform with local codes or, in the absence of local codes, the National Fuel Gas Code, ANSI Z223.1/NFPA 54.

When applicable, the installation must conform with the Manufactured Home Construction and Safety Standard, Title 24 CFR, Part 3280.

Do not install this water heater in a recreational vehicle, trailer, boat or other moving vehicles as it will result in a Carbon Monoxide Poisoning Hazard.

Contents

1. Important Safety Information	3
2. About the Water Heater	7
2.1 Description of the Water Heater	7
2.2 Parts of the Water Heater	7
2.3 The Front Panel (Universal/Interior Models Only)	8
2.4 Remote Controller (Exterior Models - Optional for Universal/Interior Models)	9
3. Operating the Water Heater	10
3.1 Turning the Water Heater On or Off	10
3.2 Adjusting the Water Temperature	11
3.3 Viewing Basic Information (Universal/ Interior Models Only)	12
3.4 Resetting the Water Heater	12
3.5 Entering Lock Mode	13
3.6 Setting the Clock	13
3.7 Setting the Recirculation Timer	14
3.8 Starting Recirculation	15
3.9 Canceling Timer Settings	15
4. Maintaining the Water Heater	16
4.1 Cleaning the Water Heater	16
4.2 Draining the Water Heater	16
4.3 Flushing the Heat Exchanger	18
4.4 Cleaning the Inlet Water Filter	20
4.5 Protecting the Water Heater from Freezing	21
5. Troubleshooting	23
5.1 Solving Basic Problems	23
6. LIMITED WARRANTY NAVIEN, INC.	24

Product Installation Information	
Model	
Date Purchased	
Gas Type	
Serial Number	

1. Important Safety Information

The following Safety Alert Symbols are used in this manual. They are used to alert you to potential personal injury hazards. Obey all safety messages that follow this symbol to avoid possible serious injury or death. These Safety Alert Symbols precede any safety message about risk of personal injury. It may also be accompanied by one of the following signal words.

If the information in these instructions is not followed exactly, a fire or explosion may result, causing property damage, personal injury or death.

⚠ DANGER

Indicates a hazardous situation that if not avoided will result in death or serious injury.

⚠ WARNING

Indicates a hazardous situation that if not avoided could result in death or serious injury.

⚠ CAUTION

Indicates a potentially hazardous situation that if not avoided could result in minor or moderate injury.

NOTICE

Indicates information considered important but not hazard-related (such as property damage).

⚠ WARNING

To prevent death, serious injury, or property damage:

If you do not follow these instructions exactly, a fire or explosion may result, causing property damage, personal injury or loss of life.

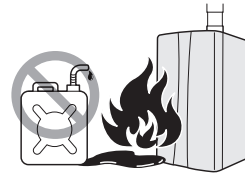

A. This appliance does not have a pilot. It is equipped with an ignition device which automatically lights the burner. Do not try to light the burner by hand.

B. BEFORE OPERATING smell all around the appliance area for gas. Be sure to smell next to the floor because some gas is heavier than air and will settle on the floor.

WHAT TO DO IF YOU SMELL GAS

- Do not try to light any appliance.
- Do not touch any electrical switches or use landline phones.
- From a neighbor's phone, call your gas provider and follow their instructions.
- If you cannot reach your gas supplier, call the fire department.

C. Use only your hand to push in or turn the gas control knob. Never use tools. If the knob will not push in or turn by hand, don't try to repair it, call a qualified service technician. Force or attempted repair may result in a fire or explosion.

D. Do not use this appliance if any part has been under water. Immediately call a qualified service technician to inspect the appliance and to replace any part of the control system and any gas control which has been under water.

⚠ DANGER



Water temperature over 125°F (52°C) can cause severe burns instantly or death from scalds. Children, disabled and elderly are at highest risk of being scalded. Feel water with your elbow before bathing or showering. Temperature limiting valves are available, contact a licensed plumber for more information.

To prevent burns:

- Use the lowest operating temperature setting necessary to provide comfortably-hot water.
- If your household has children or elderly or disabled residents, consider using a lower temperature setting.
- Check local codes for maximum water temperature setting allowed when used in nursing homes, schools, day care centers and other public applications.
- Do not leave children, the elderly, or disabled persons unsupervised.
- Do not allow small children to play unsupervised in the bathroom.
- Do not allow anyone to change the water temperature while hot water is running.
- Read all the instructions in this manual carefully before changing the temperature setting.
- Feel the water before using it on children, the elderly, or the disabled.
- If it is necessary to set the water temperature above 125°F (52°C), consider installing a thermostatically-controlled mixing valve or temperature-limiting valve. Contact a licensed plumber or your local plumbing authority for more information.

⚠ DANGER

This water heater is set to 120 °F (49 °C) at the factory for your safety and comfort. Increasing the temperature increases the risk of accidental scalding. Water temperatures at or above 125 °F (52 °C) can cause instant scalding, severe burns, or death. Before you decide to change the temperature setting, read the following table carefully.

Water Temperature	Time in which a young child can suffer a full thickness (3rd degree) burn
160 °F (70 °C)	Less than 1 second
140 °F (60 °C)	1 second
130 °F (55 °C)	10 seconds
120 °F (49 °C)	10 minutes
100 °F (37 °C)	very low scald risk

Before setting the temperature at or above 125 °F (52 °C), consider installing a thermostatically-controlled mixing valve or temperature-limiting valve. Contact a licensed plumber or your local plumbing authority for more information.

SAVE THESE INSTRUCTIONS

⚠ DANGER

Indicates a hazardous situation that if not avoided will result in severe injury or death.

⚠ WARNING

Indicates a hazardous situation that if not avoided could result in death or serious injury.

⚠ CAUTION

Indicates a potentially hazardous situation that if not avoided could result in minor or moderate injury.

NOTICE

Indicates information considered important but not hazard-related (such as property damage).

WARNING

To prevent death, serious injury, or property damage:

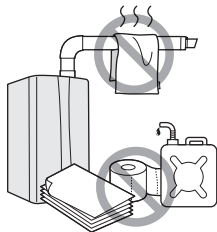

- **Shut off the gas supply if the water heater is damaged.**

Have your installer or plumber show you the location of the gas shut off valve and demonstrate how to close the valve. If the water heater is damaged as a result of overheating, fire, flood, or any other reason, close the manual shut off valve and do not operate the water heater again until it has been inspected by a qualified technician.

- **Do not store or use gasoline or other flammable liquids near this water heater.**

Doing so may result in fire or explosion.

- **Do not place combustibles, such as newspapers or laundry, near the water heater or venting system.**

Doing so may result in a fire.

- **Do not place or use hair sprays, spray paints, or any other compressed gases near the water heater or venting system, including the vent termination.**

Doing so may result in fire or explosion.

- **Do not remove the front cover unless the power to the water heater is turned off or disconnected.**

Failure to do so may result in electric shock.

- **Do not operate the water heater with the front cover opened.**

Doing so may result in fire or carbon monoxide (CO) poisoning, which may result in property damage, personal injury, or death.

WARNING

To prevent death, serious injury, or property damage:

- **Do not operate this water heater without proper venting.**

Doing so may result in fire or carbon monoxide (CO) poisoning, which may result in property damage, personal injury, or death. Inspect the vent termination and air intake supply annually to ensure proper operation of the water heater. Turn off and discontinue use of the water heater if any of the vent pipes, vent elbows, or intake pipes are damaged in any way, separated at a joint, or show evidence of corrosion, rusting, or melting.

- **Do not touch the power cord or internal components of the water heater with wet hands.**

Doing so may result in electric shock.

California law requires the following Prop 65 warning to be provided:

WARNING

Cancer and Reproductive Harm -
www.P65Warnings.ca.gov

CAUTION

- **Do not attempt to repair or replace any part of the water heater, unless it is specifically recommended in this manual.**

For all other service, contact an authorized technician or licensed professional. Improper adjustments, alterations, service, or maintenance may lead to property damage, personal injury, or death and will void your warranty.

- **Do not operate the water heater if you feel something is wrong with it.**
Doing so may result in product damage or personal injury.
- **Do not allow children to operate or access the water heater.**
Doing so may result in product damage or personal injury.
- **Do not attempt to change the water temperature while the water heater is being used.**
Doing so may result in personal injury.
- **Do not turn on the water heater unless the water and gas supplies are fully opened.**
Doing so may damage the water heater.
- **Do not turn on the water if the cold water supply shut-off valve is closed.**
Doing so may damage the water heater.
- **Do not use this water heater for anything other than its intended purpose, as described in this manual.**
- **When servicing the controls, label all wires prior to disconnecting them.**
Failure to do so may result in wiring errors, which can lead to improper or dangerous operation. Verify proper operation after servicing.
- **Do not use unapproved replacement or accessory parts.**
Doing so may result in improper or dangerous operation and will void the manufacturer's warranty.
- **Do not place anything in or around the vent terminals, such as a clothes line, that could obstruct the air flow in or out of the water heater.**

CAUTION

- **This water heater has been approved for use in the USA only.**

Using the water heater in any other country will void the manufacturer's warranty.

- **Should overheating occur or the gas supply fail to shut off, turn off the manual gas valve to the appliance.**
- **Do not use this appliance if any part has been under water.**
Immediately call a qualified service technician to inspect the appliance and to replace any part of the control system and any gas control which has been under water.

2. About the Water Heater

2.1 Description of the Water Heater

The NHW700-series water heater is available in 12 models:

NHW700-160SE, NHW700-180SE, NHW700-199SE, NHW700-160SU, NHW700-180SU, NHW700-199SU, NHW700-160AE, NHW700-180AE, NHW700-199AE, NHW700-160AI, NHW700-180AI and NHW700-199AI.

- U (Universal): For INDOOR and OUTDOOR* use
*With Navien Outdoor Vent Kit
- I (Interior): For INDOOR use ONLY
- E (Exterior): For OUTDOOR use ONLY
- S (Standard): Without Buffer Tank and pump ("SE/SU" Model Only)
- A (Advanced): Built-in Pump and 0.4 US Gallon (1.5 liter) Buffer Tank for internal or external recirculation ("AI/AE" Model Only)

The main features are as follows:

- Potable domestic hot water and combination space heating
- Maximum temperature: 140°F (60°C)
- Stainless steel heat exchanger with stainless steel piping

2.2 Parts of the Water Heater

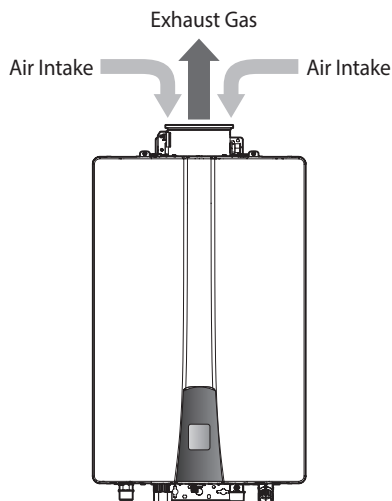

[NHW700-SU/AI Models]

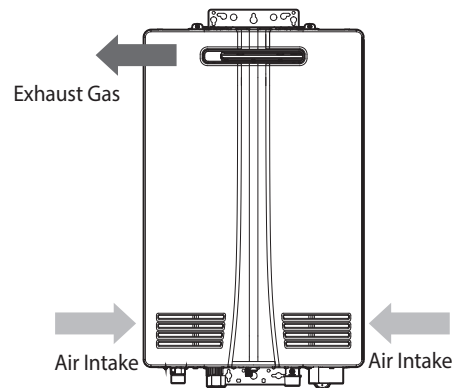

[NHW700-SE/AE Models]

2.2.1 Bottom View of NHW700-SE/SU Models

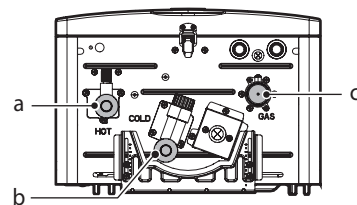

#	Description	Remark
a	Hot Water Outlet Connection	
b	Cold Water Inlet Connection	
c	Gas Inlet	

2.2.2 Bottom View of AI/AE Models

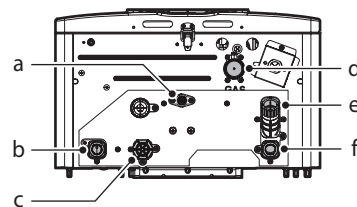

#	Description	Remark
a	Pump Drain Port	"AI/AE" Models Only
b	Hot Water Outlet Connection	
c	Recirculation Inlet	"AI/AE" Models Only
d	Gas Inlet	
e	Inlet Water Filter	"AI/AE" Models Only
f	Cold Water Inlet Connection	

2.3 The Front Panel (Universal/Interior Models Only)

The front panel allows you to adjust the water temperature and view the operating status or error codes. Remove the protective sheet from the front panel before using it.

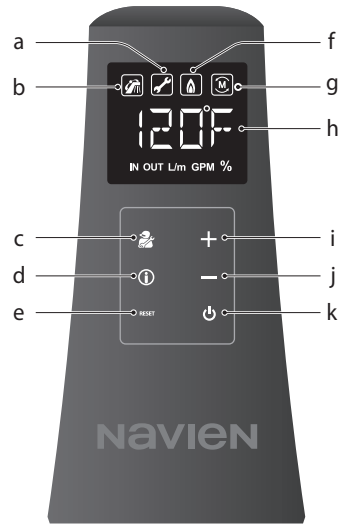

Error

A code will appear on the display



Hot Water Recirculation

Recirculation Mode



Diagnostics button

For installers only



Information button

Shows basic information



Reset button

Resets the water heater (When an error occurs)



Combustion

When the gas burner is on



Master Unit

Cascade operation



Display



Up button

Increases the temperature



Down button

Decreases the temperature



Power button

Turns the water heater on or off

2.4 Remote Controller (Exterior Models - Optional for Universal/Interior Models)

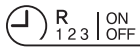
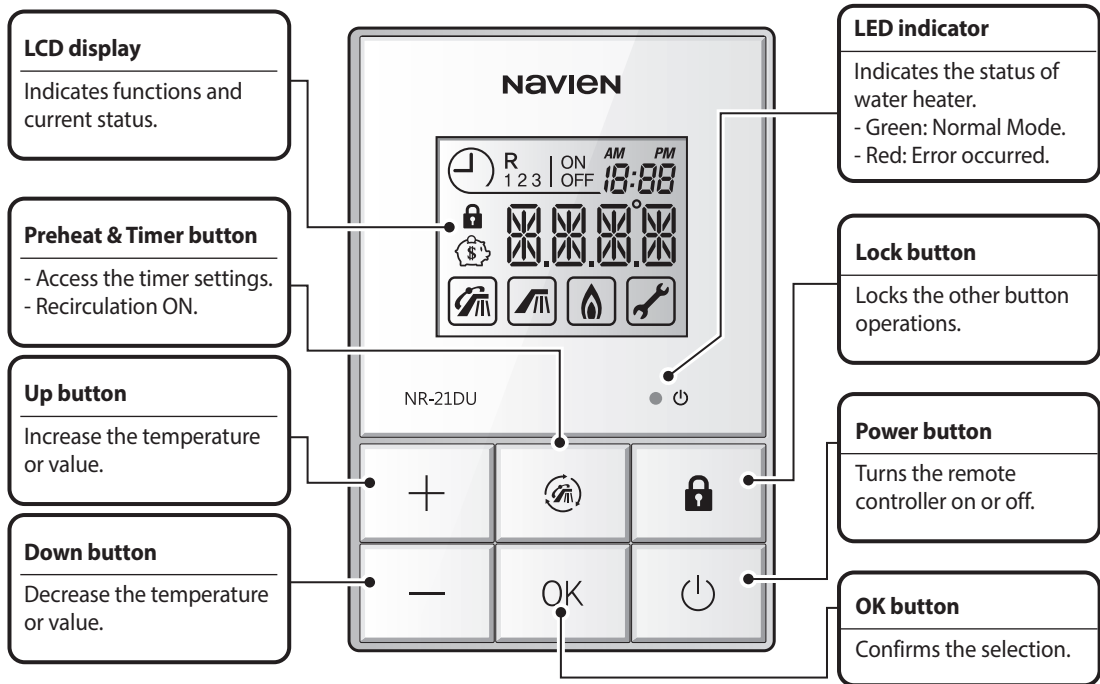

Timer is set.



Recirculation Mode.



Displays the current time.



Hot water is in use.



Displays the current set temperature.



Water heater operation is in progress.



Operations are locked.



An error code will appear on the display.

3. Operating the Water Heater

⚠ WARNING

To prevent death, serious injury or property damage:

- Ensure that the water heater is filled with water before turning on the water heater.
- If overheating occurs or the gas supply fails to shut off, shut off the gas supply to the water heater at the manual gas valve.
- If any part of the water heater has been submerged in water, do not use this appliance and immediately call a qualified service technician. The water heater must be replaced.

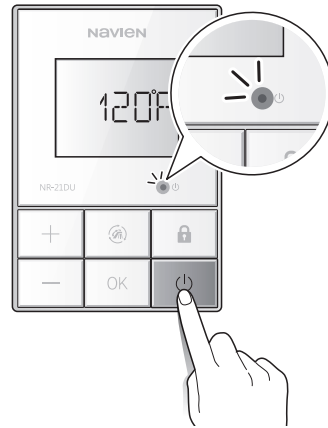

[Exterior Models with Remote Controller]

3.1 Turning the Water Heater On or Off

To turn the water heater on or off, press the Power button.

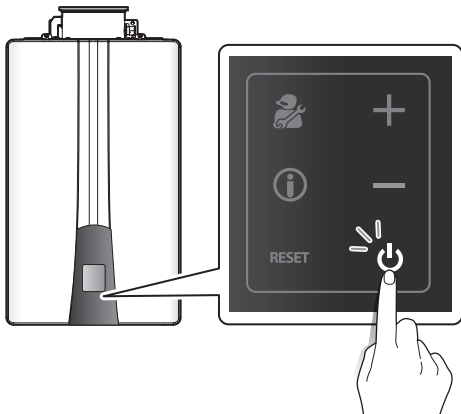

[Universal/Interior Models]

When the power is on, the temperature will appear on the front panel display.



[Universal/Interior Models]



[Exterior Models with Remote Controller]

3.2 Adjusting the Water Temperature

WARNING

Before adjusting the water temperature, read “To prevent burns:” on page 4 carefully. Water temperatures above 120 °F can cause instant scalding, severe burns, or death.

The water heater is set to 120 °F (49 °C) by default. To adjust the water temperature:

1. Make sure that all hot water faucets are closed, and ensure that the internal circulator and any external circulating pumps are off.

Note If a hot water faucet is open, you can adjust the temperature only from 98-110 °F (37-43 °C).

2. Press the + (Up) or – (Down) buttons until the desired temperature appears on the display. You can adjust the temperature while the display is flashing. Once the display stops flashing, the temperature setting is stored.

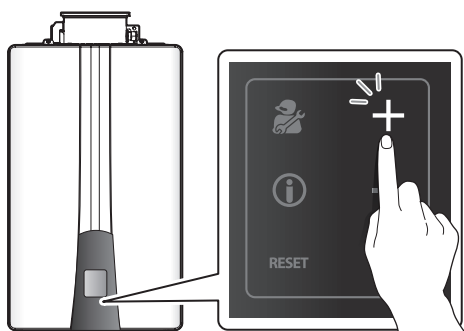

[Universal/Interior Models]

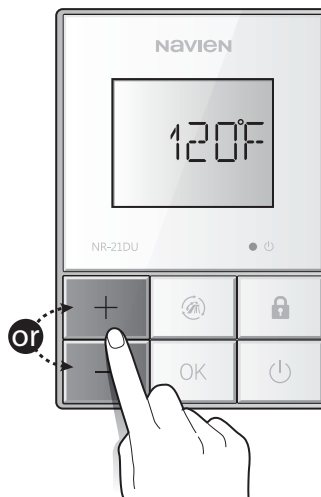

[Exterior Models with Remote Controller]

Note The water heater will retain your settings during a power outage.

You can adjust the temperature by the increments as shown below based on the desired temperature range.

Temperature range	Adjusting the water temperature
98 °F-140 °F (Fahrenheit mode) 36 °C-60 °C (Celsius mode)	1 °F or 0.5 °C increments

The water heater will not provide hot water instantly at the hot water faucet unless a recirculation line has been installed from the furthest fixture back to the water heater.

3.3 Viewing Basic Information (Universal/Interior Models Only)

To view information about the water heater, press the Information button.

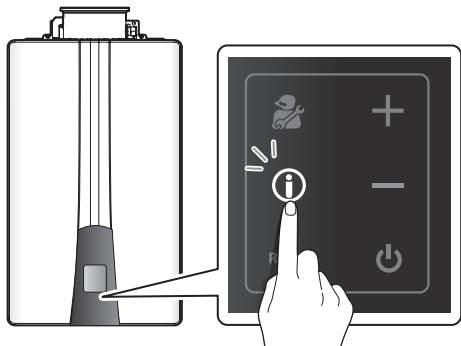

Press the + or – buttons to switch between the information types.

Display	Description
	Flow rate in gallons per minute (GPM).
	Hot water outlet temperature (OUT).
	Cold water inlet temperature (IN).

To exit information mode, press the Reset button.

3.4 Resetting the Water Heater

If an error message appears, you can try resetting the water heater to resolve the problem. To reset the water heater, press the Reset button.

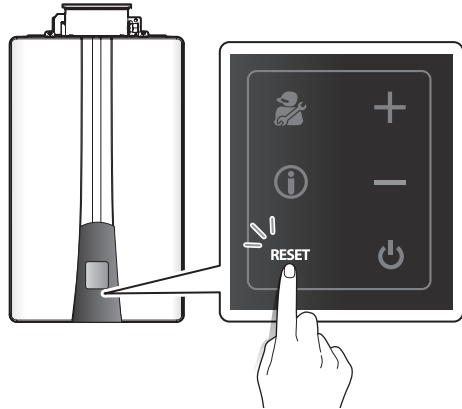

For outdoor installation models, press the OK button once and “RST” will be displayed on the LCD display.



If resetting the water heater does not solve the problem, refer to the Troubleshooting section of this manual or contact Technical Support at 1-800-519-8794.

3.5 Entering Lock Mode

To prevent accidental pressing of the buttons and to prevent children from adjusting the controller, you can activate the Temperature Lock Mode.

To activate or deactivate Lock Mode, press the Lock button for 2 seconds.

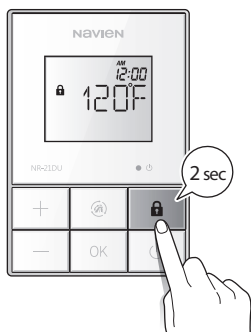

When Lock Mode is activated,

- The Lock icon appears on the display.
- All buttons except for Lock button are locked.

Note

- Resetting errors or alarms is still available with Lock Mode activated.
- You can change the settings from the front panel with Lock Mode activated.

3.6 Setting the Clock

1. Press the Preheat & Timer button for 2 seconds.

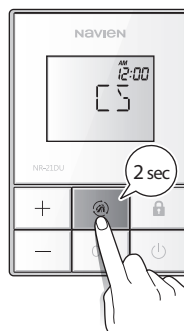

2. Adjust the minutes by pressing the Up or Down Button.

Press the OK button to set the minutes.

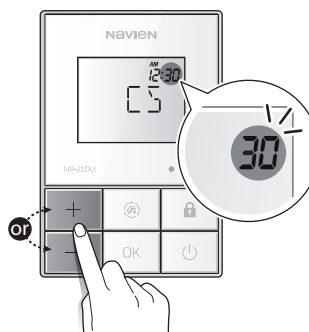

3. Once the minutes are set, adjust the hour by pressing the Up or Down button.

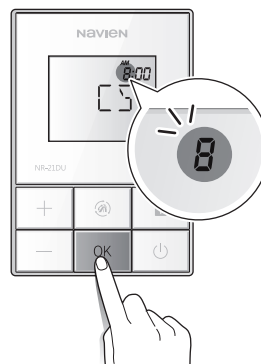

4. Press the OK button to finish and save the updated time.



2. Set the recirculation activation time by pressing the Up or Down button.

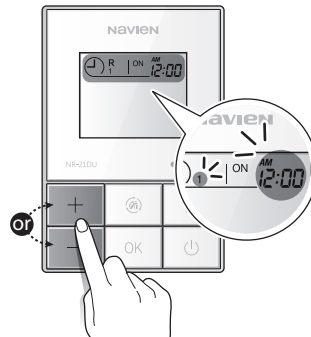

Then, press the OK button to set the deactivation time.

Note The recirculation timer settings are divided in 30 minute increments.

3.7 Setting the Recirculation Timer

1. Press the Preheat & Timer button to set the Recirculation timer while setting the clock. Reservation Schedule #1 is ready to be set.

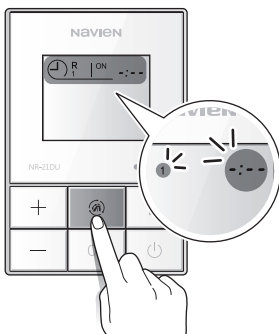

Note This feature is available only when external circulating pumps are connected and ON.

3. Set the deactivation time by pressing the Up or Down button.

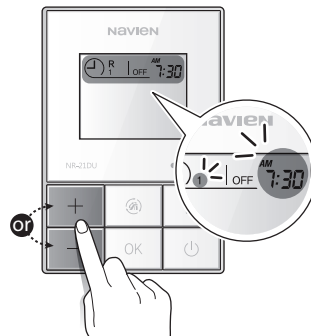

- Press the OK button to save the timer setting. Repeat these procedures for Reservation Schedule Settings #2 and #3.



- During the reservation schedule, the preheating icon turns on and the Reservation area starts flashing.

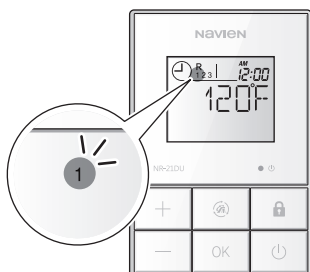

3.8 Starting Recirculation

Press the Preheat & Timer button to start recirculation immediately, regardless of the reservation schedule.

"HEAT" appears for 4 seconds on the display and then recirculation runs once.



During the recirculation, the preheating icon flashes continuously.

Note

- This feature is available only when external circulating pumps are connected and ON.
- This feature runs during the recirculation time set on the front panel which the remote controller is connected to.

3.9 Canceling Timer Settings

Press and hold the Preheat & Timer and OK button simultaneously for 2 seconds.

"CLR" appears for 3 seconds and all timer settings are canceled.

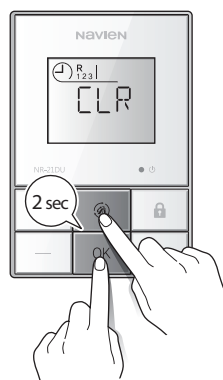

4. Maintaining the Water Heater

4.1 Cleaning the Water Heater

⚠ WARNING

Make sure the water heater is turned off and the power supply is disconnected before cleaning the water heater. The water heater may remain hot for several minutes after it is turned off. To prevent burns, wait until the water heater has cooled down before cleaning.

To clean the water heater, wipe the outside with a damp cloth. Use a non-acidic, non-abrasive cleaner to remove any surface stains. The front panel is moisture resistant, but it is not waterproof. Keep it as dry as possible.

4.2 Draining the Water Heater

You need to drain the water heater before performing maintenance tasks, such as cleaning the inlet water filter, or to prevent the water heater from freezing when it will not be used for an extended period.

Refer to the “2.2 Parts of the Water Heater” on page 7 for details about part locations.

To drain the water heater:

1. Place a bucket under the water heater, to collect the residual water inside the water heater.
2. Press the Power button on the front panel to turn off the power to the water heater.

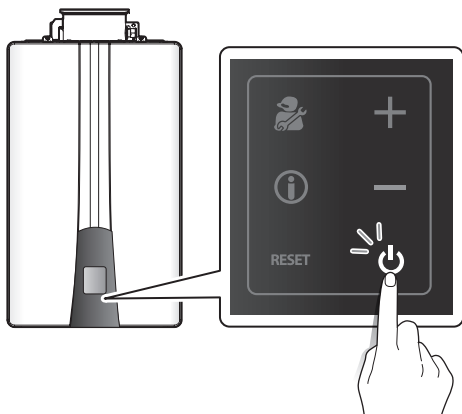

[Universal/Interior Models]

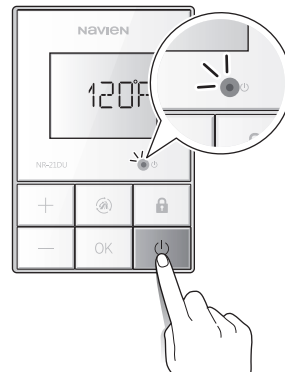

[Exterior Models with Remote Controller]

3. Close the gas shut-off valve.

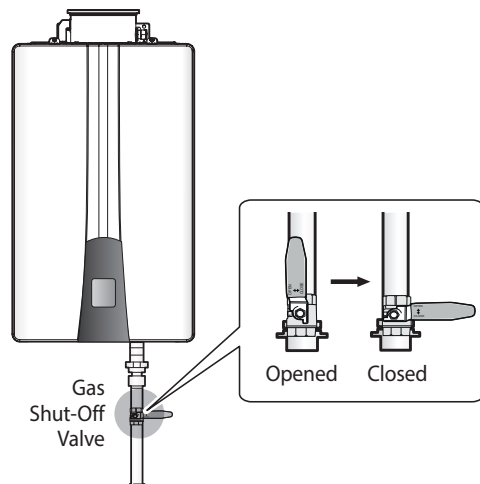

- Close the water supply valve on the inlet to the water heater. If there is no valve, turn off the water supply at the water main.

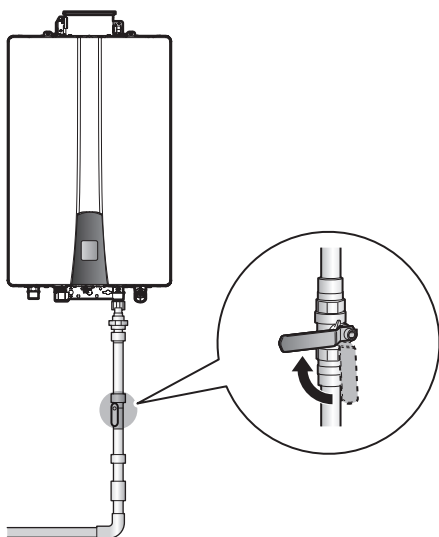

Remove the recirculation inlet filter from the bottom of the water heater (AI/AE models only).

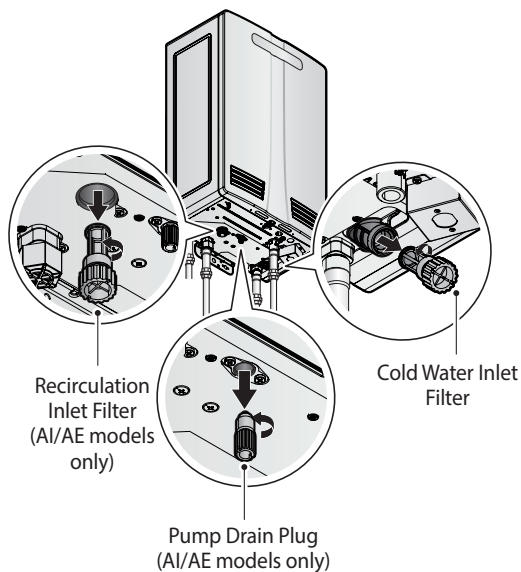

[NHW700-AI/AE Models]

- Open all hot water faucets completely. The water that remains in the plumbing lines will drain out.
- Open the water drain plug (SE/SU models only).

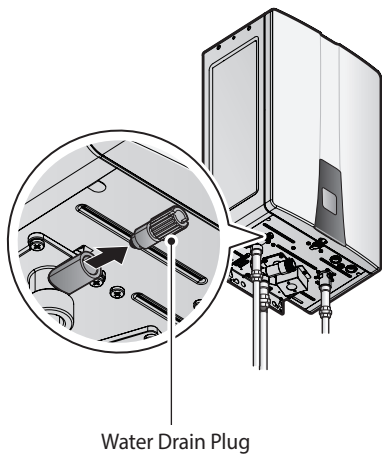

[NHW700-SE/SU Models]

- Open the pump drain plug (AI/AE models only).
- Remove the cold water inlet filter.
- Allow the residual water to drain from the water heater.
- When the water is completely drained, reinsert the cold water inlet filter, and then close the water drain plug.
- To refill the water heater follow the steps of "Draining the Water Heater" in reverse.

4.3 Flushing the Heat Exchanger

NOTICE

Flushing the Heat Exchanger can be a difficult procedure. Read the following instructions carefully before attempting this procedure. If you are uncertain about any of the steps in the procedure, contact an authorized technician or licensed professional. Keep in mind that improper maintenance can void your warranty.

About Water Quality

Proper maintenance of the water heater is required when water quality does not meet EPA standards. Damage caused by poor water quality is not covered under warranty. The following table shows the maximum contaminant levels allowed, based on the EPA National Secondary Drinking Water Regulations (40 CFR Part 143.3). If you suspect that your water is contaminated in any way, discontinue use of the water heater and contact an authorized technician or licensed professional.

Contaminant	Maximum Allowable Level
Total Hardness	Up to 200 mg/l (12 grains/gallon)
Aluminum	0.05 to 0.2 mg/l
Chloride	Up to 250 mg/l
Copper	Up to 1.0 mg/l
Iron	Up to 0.3 mg/l
Manganese	Up to 0.05 mg/l
pH	6.5 to 8.5
Sulfate	Up to 250 mg/l
Total Dissolved Solids (TDS)	Up to 500 mg/l
Zinc	Up to 5 mg/l
Chlorine	Up to 4 mg/l

If your local water is hard, please review the following recommended treatment and flushing guidelines.

Hardness Level		Treatment Method	Flush Frequency*
Soft	0-4 grains/gal (0-60 mg/L)	None	None
Moderately Hard	4-7 grains/gal (61-120 mg/L)	Water Softener** or Navien PeakFlow is Recommended	Once/Year
Hard	7-9 grains/gal (121-160 mg/L)	Water Softener** or Navien PeakFlow is HIGHLY Recommended	Residential: Once/Year
Very Hard	9-12 grains/gal (161-200 mg/L)	Water Softener** or Navien PeakFlow is Required	
Extremely Hard	>12 grains/gal (200 mg/L)	Water Softener** or Navien PeakFlow is Required	

* **Flushing is recommended if a treatment device is not installed.** This procedure should be performed using white vinegar or solutions that are specifically formulated for use on tankless water heaters. See page 18 for more information on flushing the heat exchanger.

**Check local codes for any restrictions on use of water softeners.

Refer to the "2.2 Parts of the Water Heater" on page 7 for details about part locations.

Before flushing the Heat Exchanger, gather the following items:

- A bucket that is 5 gallons or larger
- Cleaning solution diluted with water
- 3 hoses
- A water circulation pump

To flush the Heat Exchanger:

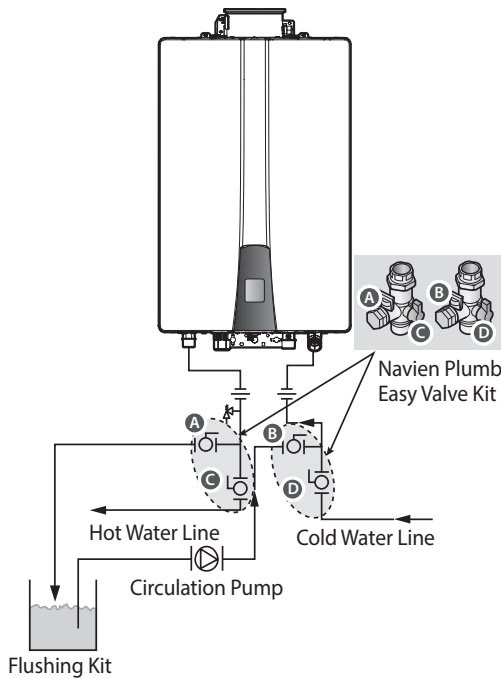

1. Press the Power button on the front panel to turn off the water heater.
2. Disconnect the power supply to the water heater.
3. Close the "C" and "D" valves on the hot and cold water lines.
4. Connect one tube to the "A" valve and place the free end in the bucket.
5. Connect one of the tubes to the circulation pump outlet and the cold water line at the "B" valve.
6. Connect one tube to the circulation pump inlet and place the free end in the bucket.
7. Pour the cleaning solution into the bucket.
8. Open both "A" and "B" valves.
9. Turn on the circulation pump and allow the solution to circulate through the water heater for at least 45 minutes.

10. Rinse the cleaning solution from the water heater:
 - a. Remove the free end of the drain tube from the bucket and place it in the condensate drain or laundry tub (wherever the water heater drains).
 - b. Close the "B" valve and open the "D" valve. Do not open the "C" valve yet.
 - c. Allow water to flow through the water heater for 5 minutes.
 - d. Close the "A" valve and open the "C" valve.
11. Disconnect all tubes.
12. Remove the cold water inlet filter from the water heater and clean out any residue.
13. Reinsert the filter and ensure the filter cap is securely tightened.
14. Reconnect the power supply to the Water Heater.
15. Press the Power button on the front panel to turn on the water heater.

4.4 Cleaning the Inlet Water Filter

To clean the filter:

1. Drain the water heater. Refer to “4.2 Draining the Water Heater” on page 16.
2. While the filters are removed, rinse it with clean running water (cold) and, if necessary, scrub it clean with a brush.

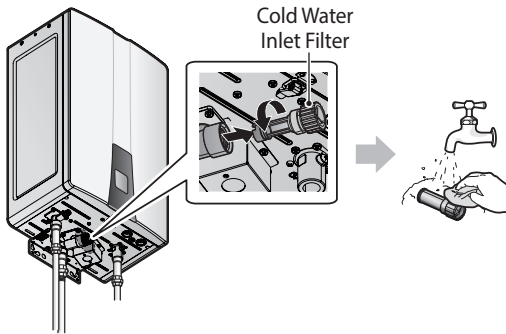

[NHW700-SE/SU Models]

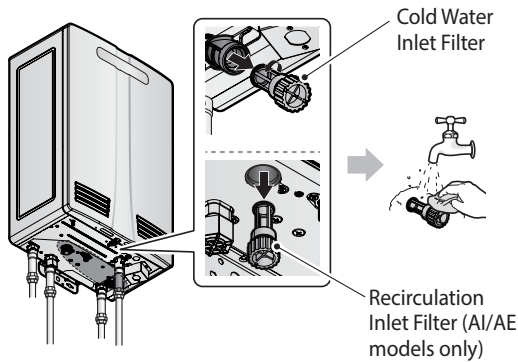

[NHW700-AI/AE Models]

3. Reinsert and tighten the filters.

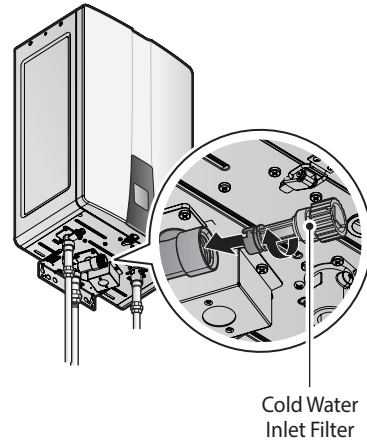

[NHW700-SE/SU Models]

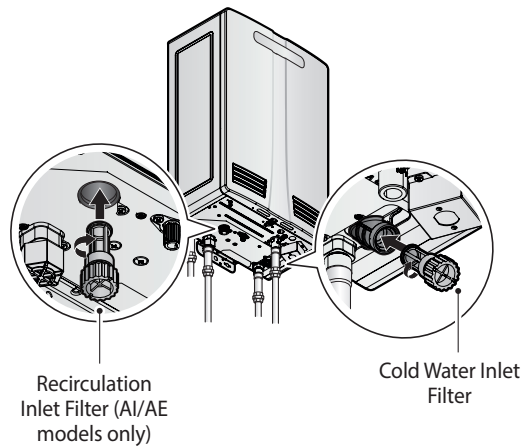

[NHW700-AI/AE Models]

4. Refill the water heater. Refer to “4.2 Draining the Water Heater” on page 16.

4.5 Protecting the Water Heater from Freezing

NOTICE

Damage due to freezing is not covered by the Navien limited warranty.

- Freezing damage is most likely to occur due to back drafting caused by negative pressure in the building. This is not a manufacturing defect, and therefore, Navien will not warrant any damages due to freezing. The installer is responsible for ensuring that there is sufficient make-up air to avoid such a situation and the owner is responsible for ensuring that protection against freezing is maintained.
- To avoid freezing issues, we strongly recommend the use of a direct vent exhaust and intake system. Your installer should ensure that the exhaust vent pipe and the air intake pipe are both connected directly from the collars on the top of the water heater to the outdoors. This type of vent system minimizes air movement within the water heater.
- This water heater has an optional recirculation pump that is used for freeze protection. This pump should prevent the water heater from freezing, even if the intake air duct is not vented directly.
- The water heater is designed for indoor or outdoor installation. However, it should not be installed outdoors in areas that are prone to freezing temperatures.

To ensure that the water heater does not freeze, follow these guidelines:

- **Do not unplug the power supply cord**, except for routine maintenance. The water heater has a freeze protection function that requires electricity. The freeze protection function will operate regardless of whether or not the power is turned on or off, as long as the electric supply is still connected.
- **Do not close the gas shut-off valve**, except for routine maintenance, as this will limit additional freeze protection.
- If the power or gas supplies must be disconnected for an extended period, drain the water heater. Freezing damage may occur if there is a loss of power or an interruption in the gas supply to the water heater.

If you are not using your water heater for an extended period:

1. Completely drain the water out of the water heater.
2. Disconnect the power supply to the water heater. This prevents your water heater from freezing and being damaged.

If hot water will not flow and you suspect that the water heater is frozen, follow these steps:

1. Press the Power button on the front panel to turn off the water heater.
2. Close the gas shut-off valve.

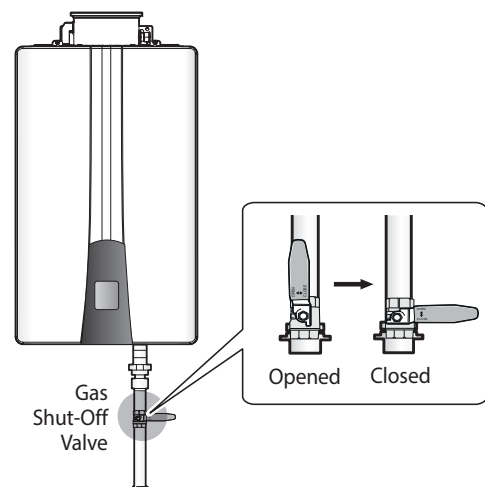

3. Open the hot water faucet that is closest to the water heater.
4. Use a hair dryer or a portable electric heater to heat up both the primary and secondary Heat Exchangers.
5. Check every few minutes to see if water is running at the open faucet.

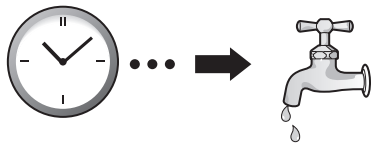

6. When the water starts flowing again, check the water heater and piping for leaks. If you detect any leaks or the water heater is not operating properly, contact an authorized technician or licensed professional.

NOTICE

If the unit will not be used immediately, close off all gas and water shutoff valves, drain all of the water out of the unit and the plumbing system to prevent the unit and system from freezing, and bleed the gas out of the gas line.

5. Troubleshooting

5.1 Solving Basic Problems

If you experience a problem with the water heater, refer to the following chart for possible remedies. Error codes that appear on the front panel display are explained in the following section.

For minor problems, resetting the water heater may resolve the issue. To reset the water heater, press the Reset button on the front panel or the OK button on the remote controller.

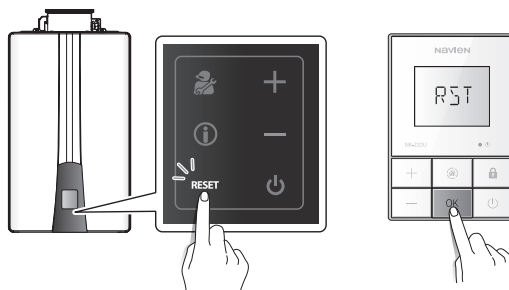

[Universal/Interior Models]

[Exterior Models with Remote Controller]

If resetting the water heater and attempting the remedies suggested below do not resolve the problem, contact an authorized technician, a licensed professional, or Technical Support at 1-800-519-8794 for service instructions.

⚠ WARNING

Do NOT attempt to service or repair the water heater yourself.

Problem	Possible Cause(s)	What to do
No water comes out when the hot water tap is opened.	<ul style="list-style-type: none"> Is the cold water inlet filter clean? Is an error code displayed on the front panel? Is the water heater frozen? 	Ensure that the shut-off valves on the hot and cold pipes are open.
The water from the hot water faucet is cold or turns cold and stays cold.	<ul style="list-style-type: none"> Is the cold water inlet filter clean? Is the hot water faucet open wide enough draw at least 0.4 gallons of water per minute (GPM) through the water heater? Is an error code displayed on the front panel? If there is an external recirculation system installed, is there a check valve on the recirculation return line? 	<ul style="list-style-type: none"> Clean the cold water inlet filter. See "4.4 Cleaning the Inlet Water Filter" on page 20. Open the hot water faucet completely.
It takes too long for hot water to reach the fixtures.	Are you using the external recirculation mode?	Have a contractor install a recirculation return line from the furthest faucet back to the water heater.
The water is not hot enough.	Is the set temperature too low?	<ul style="list-style-type: none"> Check the water heater's temperature setting. Refer to "3.2 Adjusting the Water Temperature" on page 11. Check for cross plumbing between the cold and hot water lines.
The water is too hot.	Is the set temperature set too high?	Check the water heater's temperature setting. See "3.2 Adjusting the Water Temperature" on page 11.

6. LIMITED WARRANTY NAVIEN, INC.

Effective Terms

This 15 year limited warranty on heat exchangers, 5 year limited warranty on parts, and 1 year Limited warranty on labor ("Warranty") covers defects in materials or workmanship when the Navien NHW700 Water Heater("Product") is installed by a properly licensed plumber or contractor and operated in strict compliance with the Installation & Operations manual procedures, subject to the terms within this Warranty document. Improper installation or use will void this Warranty. This Warranty runs from date of installation and extends to the original purchaser and subsequent owners, but only while the Product remains at the site of the original installation.

What is Covered?

Subject to the foregoing terms, Navien will repair or replace the covered Product or any part or component that is defective in materials or workmanship for a period of five (5) years in regard to parts and up to fifteen (15) Years in regard to the heat-exchanger for a Standard¹ or Controlled-Recirculation² installation in a Residential⁴ application. All repair parts must be genuine Navien parts. All repairs and replacements must be performed by an individual or servicing company that is properly licensed to do the type of repair.

When the Product is being used in an Uncontrolled-Recirculation³ installation in a Residential⁴ application, then the parts warranty will be reduced to three (3) years and the heat exchanger warranty to five (5) years as indicated in the Warranty Coverage Periods table.

When the Product is being used in an Standard¹ or Controlled-Recirculation² installation in a Combi⁴ or Commercial application, then the parts warranty will remain at five (5) years and the heat exchanger warranty will be reduced to five (5) years as indicated in the Warranty Coverage Periods table.

When the Product is being used in an Uncontrolled-Recirculation³ installation in a Combi⁴ or Commercial application, then the parts warranty will be reduced to three (3) years and the heat exchanger warranty to three (3) years as indicated in the Warranty Coverage Periods table.

Navien will pay labor charges for the warranty repair subject to Navien's prior written approval and in accordance with Navien's schedule of approved labor allowances for a period of one (1) year from the date of installation.

During the applicable warranty period, replacement of the Product or components may be authorized by Navien only. Navien does not authorize any person or company to assume for it any obligation or liability in connection with the replacement of the Product or its components. If it is determined that repair or replacement of a part, under warranty, is not possible, the Product will be replaced with a new Product having at least the same BTU capacity as the product at issue. The replacement component or product will be warranted only for the unexpired portion of the applicable warranty period for the original component or Product.

Warranty Coverage Periods				
Application		Labor Warranty	Parts Warranty	H/Ex Warranty
Residential ⁴	Standard ¹ or Cont-Recirc ²	1 year	5 years	15 years
	Uncont- Recirc ³	1 year	3 years	5 years
Commercial or Combi ⁴	Standard ¹ or Cont-Recirc ²	1 year	5 years	5 years
	Uncont- Recirc ³	1 year	3 years	3 years

⁴Applies only to single family, residential locations

¹ **Standard** means there is no recirculation being used

² **Controlled-Recirculation** means recirculation of the water through the water heater is controlled by either the water heater or an external aquastat.

³ **Uncontrolled-Recirculation** External pumps configured to circulate continuously through the water heater are subject to the uncontrolled recirculation warranty terms. An aquastat is the minimum pump control requirement for DHW or storage tank recirculation in order to maintain the full controlled recirculation warranty.

⁴ **Combi** refers to a combination potable water and space heating application. Water Heaters cannot be use in space heating only applications or this warranty will be voided.

How do I get service?

You must contact the original installer of your Product. Your installer will need to contact Navien to report the issue. If the original installer cannot be identified or you no longer choose to use that service provider, you may choose any service provider who is properly licensed to complete the necessary repair. The installer and/or service provider must comply with Navien's warranty service and return policy procedures as available on Navien's website including contacting Navien's Technical Support Department at (800) 519-8794, option 2, prior to commencing any service.

Proof of the date of installation must be provided to Navien. At Navien's request, the defective Product or part must be returned to Navien. When the Product is installed in new construction, the date of installation shall be established as the date upon which the end-user takes title to the real property. If proof of the installation date is unavailable, then six months after the date of manufacture will be used.

Additional terms and conditions are continued on the reverse side.



Customer Name :	
Customer Address :	
Telephone :	Fax :
Email :	
Installer Name :	License No :
Installer Address :	
Place of Purchase :	
Model No :	
Serial No :	
Date of Purchase :	



Navien, Inc.
 20 Goodyear, Irvine, CA 92618
 Tel : 1-800-519-8794
 Fax : 949-420-0430
 www.navieninc.com

For instant warranty registration, please register your product online at www.navieninc.com

What is not covered?

Navien's Limited Warranty shall be void in the event of an occurrence of any of the following:

- Improper installation, including but not limited to failure to install in strict compliance with the Installation and Operation Manual, installation in violation of applicable rules, laws or building codes, inadequate water quality, condensate damage, improper venting, incorrect gas type, water pressure, improper conversion from Natural Gas source to Propane, improper conversion from Propane source to Natural Gas, reinstallation at another location, etc.
- Accident, abuse or misuse including but not limited to installation for non-recommended uses, failure to follow or comply with the User's Operational Manual, etc.
- Improper maintenance including but not limited to, scale buildup, vent blockage, failure to maintain, etc.
- Modification, alteration, addition of non-approved components, or misapplication of the Product in any manner.
- Any damage caused by local adverse conditions including but not limited to water quality, hard water deposits, lime or mineral build-up, operating in corrosive atmospheric elements, alterations in smell or taste of water that have an adverse reaction on the unit, etc.
- Damage or problems caused by gas flow issues, electrical surges, flooding, fire, freezing, abnormal external temperature, force majeure, riot, act of war, or any acts of God.
- Performance problems caused by improper sizing of the boiler, the gas supply line, the venting connection, combustion air openings, electric service voltage, wiring, fusing or any other components, parts or specifications.
- Vibration and noise unless caused by a defect in materials or workmanship. Any other causes other than defects in materials or workmanship.
- Operating the Product at water temperatures outside the factory calibrated temperature limits and/or exceeding the maximum setting of the high limit control.
- Subjecting the heat exchanger to pressures or firing rates greater or lesser than those shown on the rating plate or removal of or alteration to the rating plate.
- Installation at any location outside the United States.
- Improper conversion from natural gas to liquid propane gas or liquid propane gas to natural gas or attempt to operate with a type of gas not specified for the boiler.
- Accidental or intentional damage.
- Operating the Product when it is not supplied with potable water at all times.

There is no warranty on any Product purchased through the internet or from any installer that obtained the Product from a supplier or distributor not authorized by Navien.

Warranty Limitations

EXCEPT AS EXPRESSLY PROVIDED HEREIN, THERE ARE NO OTHER WARRANTIES, EXPRESSED OR IMPLIED, INCLUDING, BUT NOT LIMITED TO WARRANTIES OR MERCHANTABILITY OR FITNESS FOR A PARTICULAR PURPOSE, WHICH EXTEND BEYOND THE DESCRIPTION OF THE WARRANTY HEREIN AND FURTHER NAVIEN SHALL NOT BE LIABLE FOR INDIRECT, INCIDENTAL, SPECIAL, CONSEQUENTIAL, PUNITIVE OR OTHER SIMILAR DAMAGES THAT MAY ARISE, INCLUDING LOST PROFITS, DAMAGE TO A PERSON OR PROPERTY, LOSS OF USE, INCONVENIENCE, OR LIABILITY ARISING FROM IMPROPER INSTALLATION, SERVICE OR USE OF THE PRODUCT. ANY IMPLIED WARRANTIES OF MERCHANTABILITY AND FITNESS ARISING UNDER STATE LAW ARE LIMITED IN DURATION TO THE PERIOD OF COVERAGE PROVIDED BY THIS WARRANTY, UNLESS THE PERIOD PROVIDED BY STATE LAW IS LESS.

No one is authorized to make any other warranties on behalf of Navien. Some states do not allow the exclusion or limitation of incidental or consequential damages, or how long an implied warranty lasts, so the above limitation may not apply to you.

This Limited Warranty gives you specific legal rights and you may also have other rights which vary from state to state.

Rev. 9.20.2023

Retain this document for future reference.



Memo

User's Information Manual

NHW700 Non-Condensing Water Heaters

Getting Service

If your water heater requires service:

- All repairs require pre-authorization by Technical Support.
- Request for your installer or any licensed professional to contact Technical Support at 1-800-519-8794 Option 2 once at the installation site.
- A short list of independent service providers in your area can be found on the website: www.navieninc.com/installers.
- Contact a licensed professional for the affected system (for example, a plumber, gas fitter, or electrician).

When you contact Technical Support, please have the following information at hand:

- Model number
- Serial number
- Date purchased
- Installation location and type
- Error code, if any appears on the front panel display

Version: 1.1 (November, 2023)



800.519.8794 | www.navieninc.com
20 Goodyear Irvine, CA 92618